

# Sun, Earth, Universe Exhibition

Technical Manual  
Revised 2/6/19



# Table of Contents

## Unpacking the Exhibits

Unpacking Basics	P. 3
Pallet Contents	P. 4-6
Parts List, by Component	P. 7

## Assembling the Exhibits

Reading and Seating Area	P. 8,9
Sofa, Love Seat, and Solar System Stools	P. 10
Design/Build/Test Engineering Activity	P. 11-19
Use Tools to Detect the Invisible	P. 20,21
Your Mission to Space Board Game	P. 22
Mars Landscape Play Table	P. 23
We Ask Questions About Earth	P. 24
We Ask Questions About the Sun	P. 25
We Ask Questions About the Solar System	P. 26,27
We Ask Questions About the Universe	P. 28,29

## Recommended Floor Plans

P. 30

## Maintenance and Troubleshooting

General Cleaning	P. 31
Use Tools to Detect the Invisible	P. 32,34
Design/Build/Test	P. 35-39
Flip Book Replacement, General	P. 40

## Miscellaneous

Hardware	P. 41
Finishes	P. 42
Repacking and Shipping (if needed)	P. 43-45

Note: This material is based upon work supported by NASA cooperative agreement award number NNX16AC67A and 80NSSC18M0061. Any opinions, findings, and conclusions or recommendations expressed in this material are those of the author(s) and do not necessarily reflect the view of the National Aeronautics and Space Administration (NASA).

# Unpacking the Exhibits

## Unpacking Basics

The exhibits will come packed on 6 pallets. Items will be secured to the pallets with ratchet straps, stretch wrap, and other protective materials. Inspect everything for damage upon arrival. **Pallet 6 has a red “Open First” box. This will have important items needed to assemble and install the components.** Cut through the stretch wrap taking care not to damage the components. Some items may shift when the stretch wrap and packing straps are removed.

Many of the pallets will contain cardboard boxes. Most will be filled with exhibit parts and will be labeled. Some boxes may only be used as packing support. Please recycle what you can. Some components will need some assembly, some will not. If the exhibit is to be shipped to a second location, save the pallets, ratchet straps, and other packing materials that will be needed.

### How to Release Ratchet Straps

First, press down on the first spring-loaded metal bar which is part of the outer tab. Then, swing the tab up about 180 degrees.

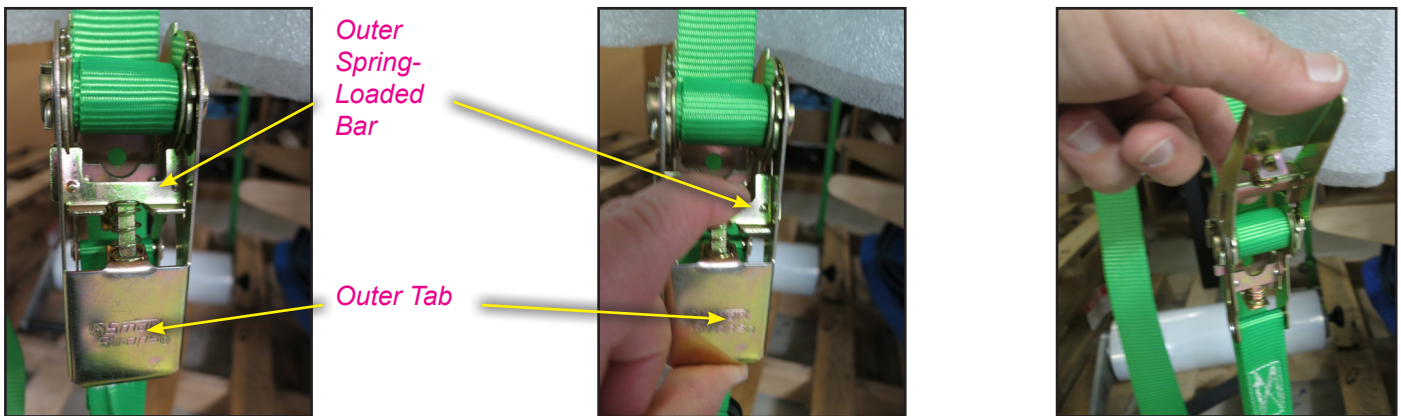

This will expose a second spring-loaded bar. Pressing that bar down will release tension on the strap, enabling it to be removed.

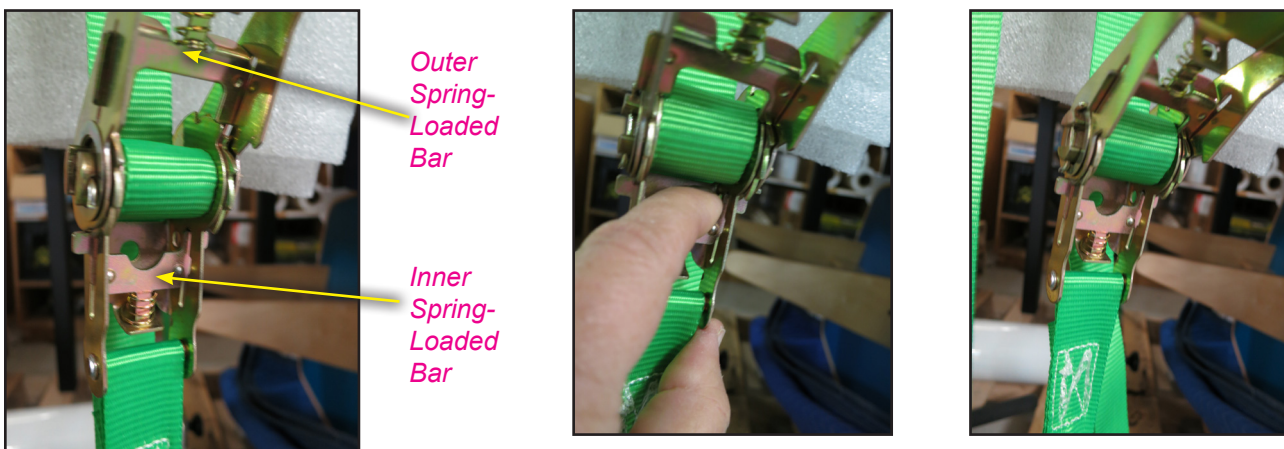



# Pallet Contents

## Pallet 1 of 6

38" x 82"

Sun Earth Universe Exhibition

### Contents:

"Use Tools to Detect the Invisible" table top

Box 1 and box 2 of Solar System stools

"Your Mission to Space" Board Game table top

Note: Wrapped exhibits will be color-coded, but may not match the colors shown here.



## Pallet 2 of 6

40" x 48"

Sun Earth Universe Exhibition

### Contents:

"We Ask Questions About the Solar System" stanchion

"Test" table top

Five boxes of legs, assorted sizes

Starter box of pixel pegs in tray

Circular "Build" graphic in a box





## Pallet 3 of 6

42" x 48"

### Sun Earth Universe Exhibition

Contents:

- "We Ask Questions About the Universe" stanchion
- Two boxes containing Ikea love seat
- "Design" table top
- "Hubble Eye" scope in a box
- Spare graphics and reader cards



## Pallet 4 of 6

40" x 48"

### Sun Earth Universe Exhibition

Contents:

- "We Ask Questions About the Earth" stanchion
- Big square Ikea sofa box 2
- Two boxes of Ikea covers
- "Design" table spacecraft model
- "Mars Landscape Play Table" top



## Pallet 5 of 6

40" x 48"

### Sun Earth Universe Exhibition

**Contents:**

"We Ask Questions About the Sun" Stanchion

"Build" table top

Three boxes of spare parts

One box of starter parts

"Design" table vitrine



## Pallet 6 of 6

40" x 48"

### Sun Earth Universe Exhibit

**Contents:**

Red "Open First" box

Visitor feedback board and bookshelf

Tall Ikea Sofa box 1

Books, reader cards, and feedback materials



# Parts List by Component

## **Design/Build/Test Engineering Activity**

“Design” table top  
“Build” table top  
“Test” table top  
Four 28” legs  
Three 29.5” legs  
Three 31” legs  
Circular graphic on a steel stand  
Cylindrical vitrine  
Vitrine model

## **Use Tools to See the Invisible**

Table with legs and “tools” attached

## **Your Mission to Mars Board Game**

Table top  
Four playing pieces  
Four 16” legs

## **Mars Landscape Play Table**

Four 16” legs  
Three Rovers  
One Mars Observer

## **Reading and Seating Area**

Bookcase  
Books  
Reader cards  
Spare reader cards  
Magnets

## **We Ask Questions About the Earth**

Earth stanchion with flip books

## **We Ask Questions About the Sun**

Sun stanchion with flip books

## **We Ask Questions About the Solar System**

Solar System stanchion with flip book  
Starter box of pixel pegs

## **We Ask Questions About the Universe**

Universe stanchion with bead jar attached  
“Hubble Eye” scope

## **Sofa, Love Seat, and Solar System Stools**

Eight stools, each with a different planet  
Tall Ikea sofa box 1  
Big square Ikea sofa box 2  
Two boxes containing Ikea love seat  
Two boxes of Ikea covers

## **Miscellaneous**

Red “Open First” box  
Spare graphics  
Three 16” x 16” x 16” boxes of spare parts  
One 16” x 16” x 16” box of starter parts



# Reading and Seating Area Title Panel



## **Bookshelf / Seating**

Sit back and relax while browsing space-themed books and reading cards.

## **Current events / Visitor feedback board**

Learn about upcoming astronomical events, local events, citizen science opportunities, and share your thoughts about space-themed questions.

Electrical Requirements: None

# Assembling the Exhibit

Place the books on the lower shelf.

Place the reader cards in the slot in the table top.

“Talk Back” materials can be placed as needed.

Lock the back up materials in the lower cabinet.

The key is a McMaster-Carr C390A cam lock key, and will be found in the red “Open First” box.

## Book List

Title	Author	Description	ISBN-10	ISBN-13	Publisher
Here We Are: Notes For Living On Planet Earth	Oliver Jeffers	Creative Non-Fiction	399167897	978-0399167898	Philomel Books
Cosmos: The Infographic Book of Space	Stewart Lowe	Non-Fiction	1781314500	978-1781314500	Aurum Press
Hello World! Solar System	Jill McDonald	Creative Non-Fiction	553521039	978-0553521030	Doubleday Books for Young Readers
Earth and Space: Photographs from the archives of NASA	Nirmala Nataraj	Non-Fiction	1452134359	978-1452134352	Chronicle Books
Light: The Visible Spectrum and Beyond	Megan Watzke	Non-Fiction	163191006X	978-1631910067	Black Dog & Leventhal
Pluto's Secret: An Icy World's Tale of Discovery	Margaret A. Weitekamp	Non-Fiction	1419715267	978-1419715266	Abrams Books for Young Readers
Max and the Tag-Along Moon	Floyd Cooper	Fiction	399233423	978-0399233425	Philomel Books
How Many Stars in the Sky?	Lenny Hort & James E. Ransome	Fiction	068815218X	978-0688152185	HarperCollins
Little Kids' First Big Book of Space	Catherine Hughes	Non-Fiction	1426310145	978-1426310140	National Geographic Children's Books
Breakfast Moon	Meg Gower	Fiction		978-1-58381-918-0	Astronomical Society of the Pacific

# Sofa, Love Seat, and Solar System Stools



A sofa and love seat provide seating for reading and activities.

Stools feature beautiful images of the planets in our solar system.

Electrical Requirements: None



## Assembling the Exhibit

Assemble the Ikea furniture according to manufacturer's instructions.

Stools are complete.



# Design/Build/Test Engineering Activity



## **Design-**

A flip book of real missions and visitor-created spacecraft serve as an inspiration for visitors planning their own craft.

## **Build-**

Visitors build a spacecraft from plastic, foam, and cardboard pieces.

## **Test-**

Visitors test their spacecraft using a parts checklist, a spin test, and a shake test.

Electrical Requirements: None

# Unpacking the Exhibit

## **The parts are:**

Three table tops- Design, Build and Test.

Four 28" steel legs

Three 29.5" steel legs

Three 31" steel legs

One Cylindrical vitrine

One Model for display

One Circular graphic on a steel stand

## **Hardware:**

Thirty lag screws, 1/4" x 1-1/4", for connecting the legs to the tables.

Four hex bolts, 1/4-20 x 2", for connecting tables to each other.

Four steel flat washers, use with the hex bolts.

Two 1/4"-20 x 3-1/2" threaded studs.

Seven 1/4"-20 x 3/4" black oxide button head cap screws:

Four for attaching the circular graphic to the table.

Three for securing the vitrine to the base.

Three white nylon bushings to use with the cap screws to secure the vitrine.

There will also be boxes containing a model part starter set, backup model parts, one mesh bag for cleaning, one spare orange belt for the shake test, and spare Velcro straps. Set these aside for the final setup.

## **Tools Needed:**

5/32 Allen wrench

7/16" socket wrench or the provided nut driver bit and a battery-powered screw gun.

Arrange all the component parts so they can be accessed when needed.

# Assembling the Tables

Two people are needed to complete this process. Assemble the "Test" table first. Work on a clean carpet or padded surface. Unpack the four 28" legs and grab 16 lag screws. The underside of each of the four corners of the table top will have a set of four pilot holes.

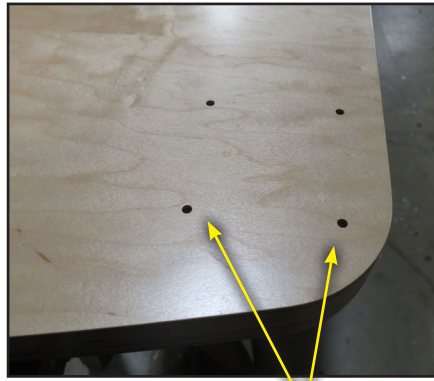
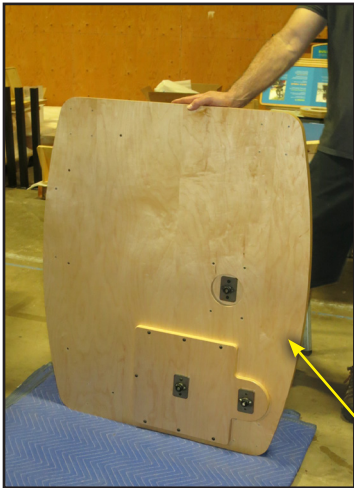

"Test" Table

Pilot Holes

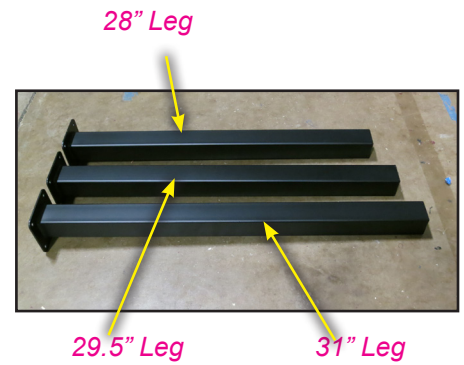

28" Leg

29.5" Leg

31" Leg



Lag Screw

Align the holes in the leg with these holes and drive the lag screws most of the way in. When all four screws have been started finish driving them in. Repeat for the other three legs.

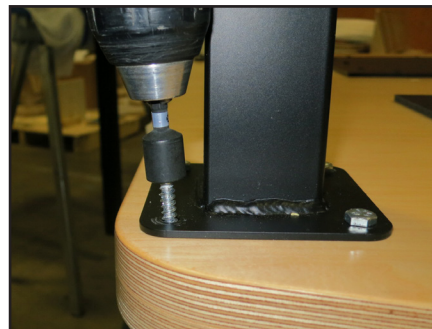

Set the table close to its desired location; the completed table will be difficult to move far.





Add the legs to the “Build” table next. Grab the three 29.5” legs and twelve more lag screws. The two hex bolts and two steel washers as well. Each “Build” table has three sets of pilot holes for legs. The fourth corner will sit on the edge of the “Test” table. Attach the legs as above.

Note that the “Test” table has two holes behind the graphic panel and that the “Build” table has two threaded inserts installed on the underside near the “missing” leg.

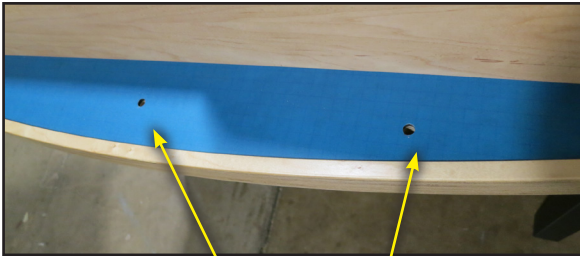

Holes in “Test” Table

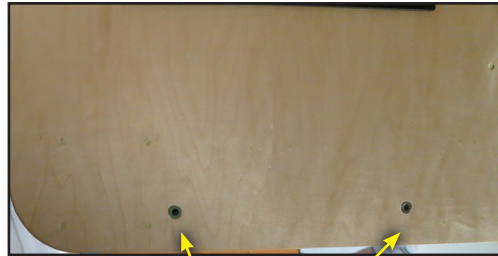

Threaded Inserts

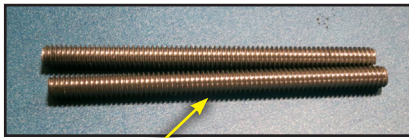

Threaded Studs

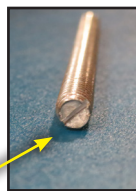

Slot

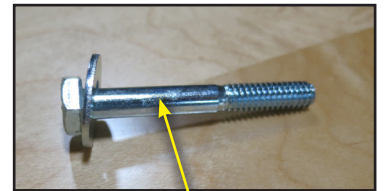

Hex Bolt

Find the two 1/4”-20 x 3-1/2” threaded studs. Note that they have a slot cut into one end. This slot will enable you to use a screwdriver to insert and remove it. Also take two hex bolts and washers. Thread the two studs into the inserts on the underside of the “Build” table, making sure the slot on the end of the stud is facing out.



Move the “Build” table so the studs align with the holes of the “Test” table and drop them in place.



Without disturbing the tables, remove one of the studs and replace it with a hex bolt and washer and finger tighten. Now, replace the second stud with another bolt and washer. Tighten both bolts with a wrench.

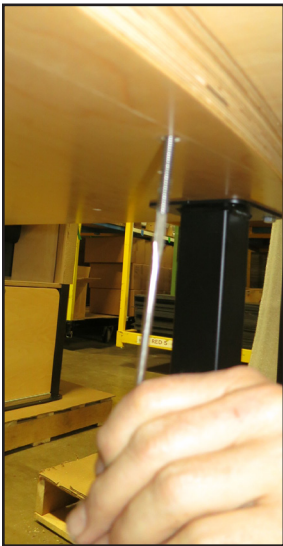

Attach the remaining three 31” legs to the “Design” table. The “Design” table connects to the “Build” table just like the “Build” table connects to the “Test” table.





# Mounting the Circular Graphic

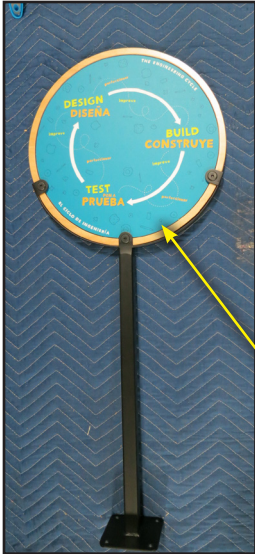

*Circular Graphic*

Next, mount the circular graphic on the “Build” table. Find the four threaded inserts embedded in the table between the “Test” table and the graphic slants. Orient the graphic so it is parallel to the flip graphic on the “Design” table, as seen below.

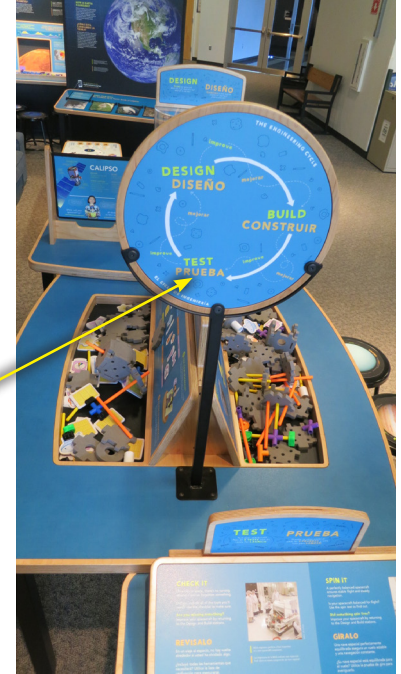

*Proper Graphic Orientation*

Take the four 1/4-20 x 3/4” black oxide button-head cap screws and thread them through the graphic base and into the threaded inserts. Tighten them using a 5/32 Allen wrench.

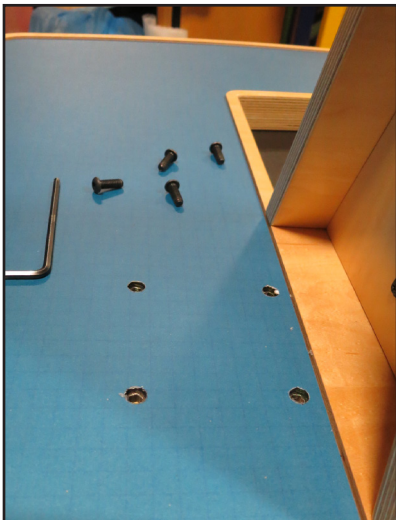



# Mounting the Model and Vitrine

Open the box containing the model.

Push the mounting rod through the small graphic with the photo of the boy and into the hole in the round base. The mounting rod needs to be pushed all the way down into the hole (1-1/2"), or the top of the model will contact the vitrine.

Rotate the graphic and model as seen below.

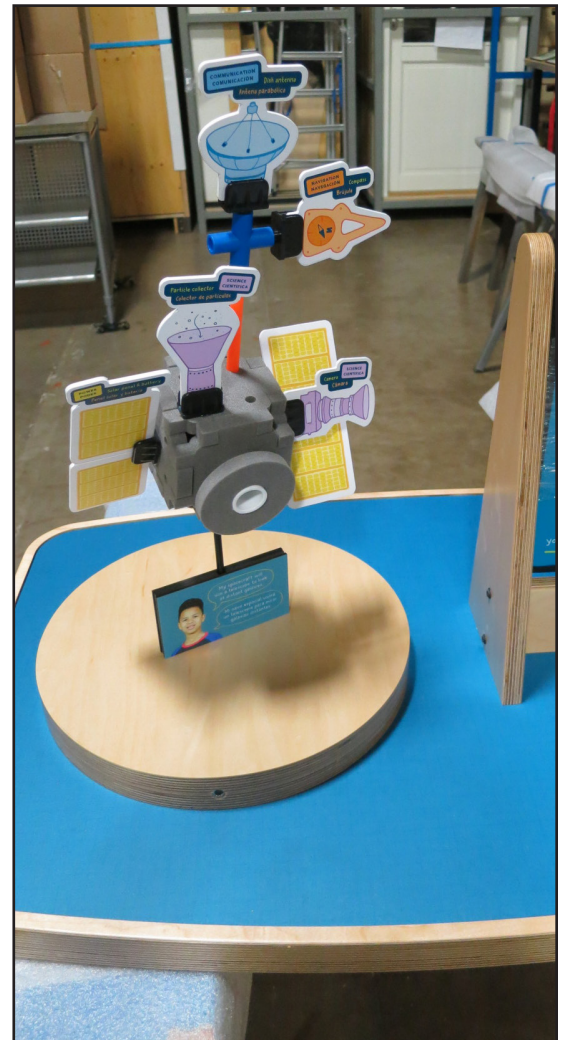
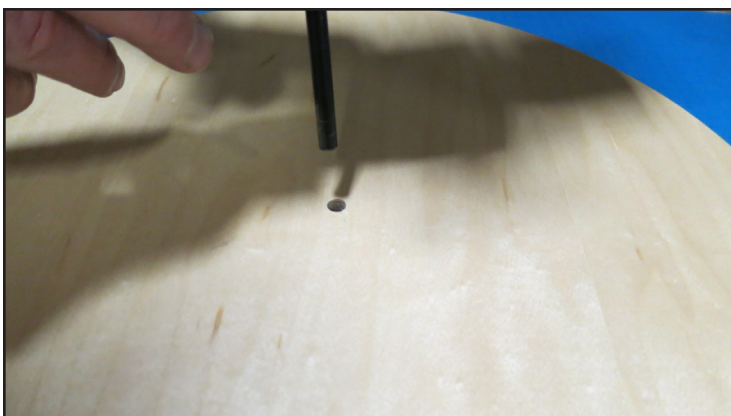

*Proper Model Orientation*

*Mounting the Vitrine, Continued...*

Clean the cylindrical vitrine with a non-solvent based cleaner.

Note: There is only one way to mount the vitrine and have the holes in the acrylic line up with the threaded inserts in the plywood base. Set the vitrine over the model and base so the graphic on the top is parallel with the flip book. If the holes in the vitrine do not at all line up with the threaded inserts in the base, rotate the vitrine 180 degrees.

From the hardware supply, take the three 1/4-20 x 3/4" black oxide button-head cap screws, the three white nylon bushings, and a 5/32" Allen wrench.

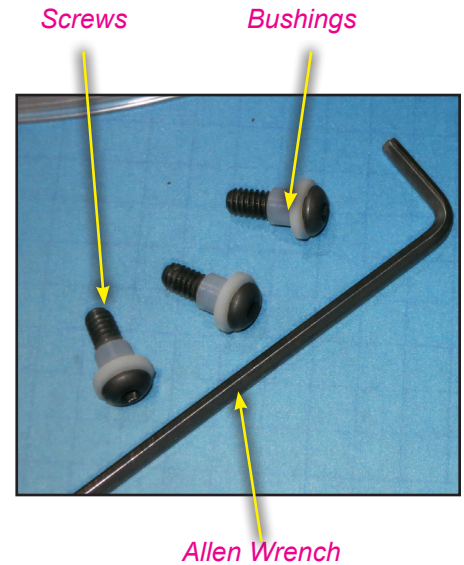

Insert the first screw and bushing through the front hole in the vitrine and start to thread it into the insert, but **only** for two or three turns. Repeat for the other two screws.

Note: It may take some fiddling around to get all three started, but it is very important to keep the screws loose until all are threaded. It is also very important to use the bushings. Failure to use the bushings will result in a cracked vitrine.

Once all three screws are started it is possible to gently hand tighten them.

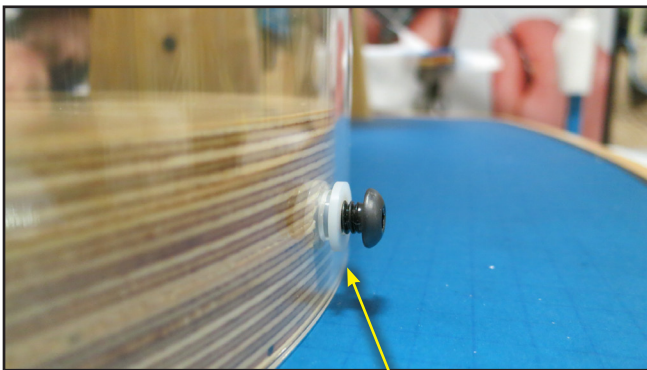

*Partially Threaded Screw*

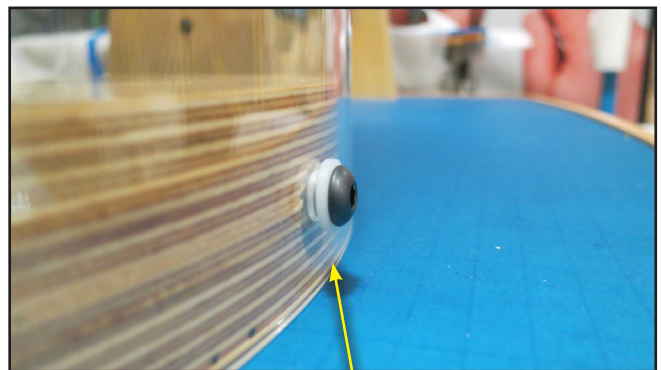

*Fully Threaded Screw*



# Model Parts

Item #	Item Description	Floor Count*
1	Foam Building Pieces with Five Small Holes	15
2	Foam Building Pieces with One Big Hole	15
3	Plain Foam Building Pieces	15
4	Large Foam Discs	15
5	Black Fasteners	30
6	1/2" PVC Couplings	10
7	Tinker Toy - 4-way Connectors	10
8	Tinker Toy - Arc Connectors	6
9	Tinker Toy - Yellow Medium Rods	12
10	Tinker Toy - Orange Long Rods	12
11	Particle Collectors	6
12	Compass	6
13	Gyroscopes	6
14	Solar Panels	24
15	Spectrographs	6
16	Cameras	6
17	Straight Antennas	6
18	Dish Antennas	6
19	Nuclear Generator	6

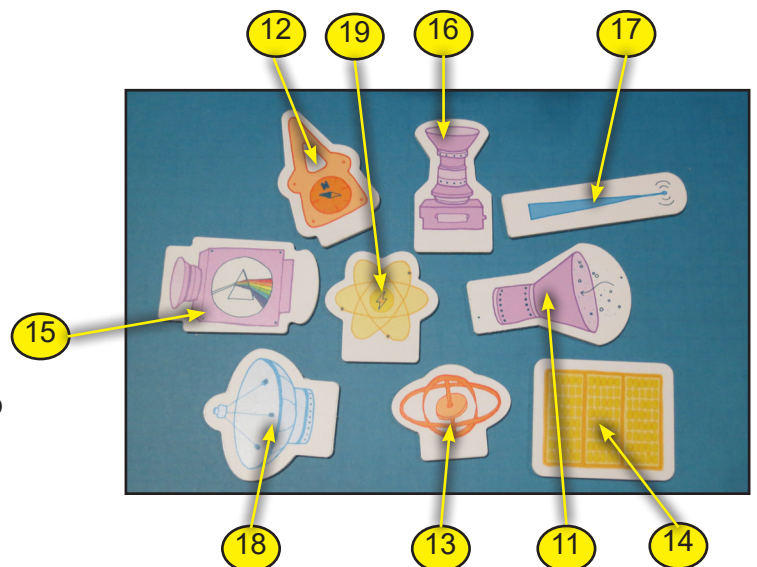
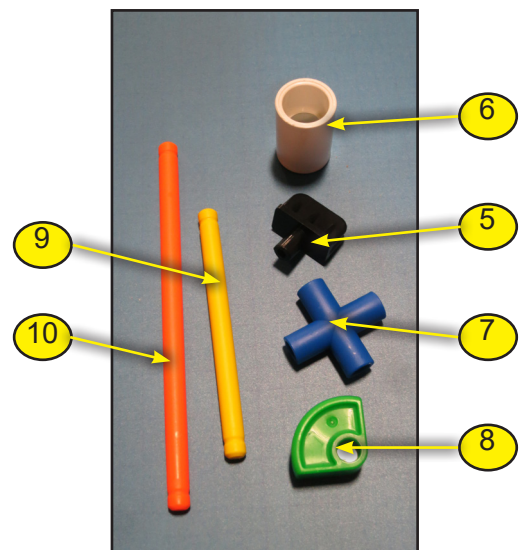
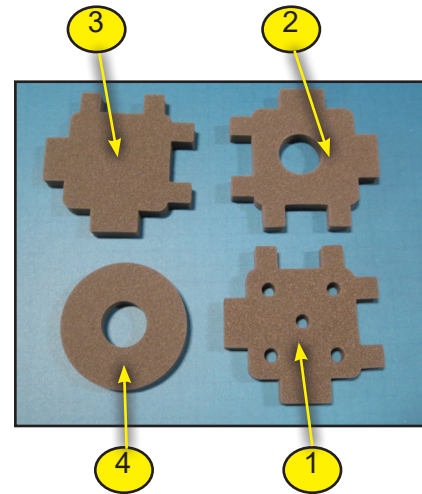

\* Put the starter set in the exhibit trays and keep the remaining stock in reserve until parts wear out or disappear.

# Use Tools to Detect the Invisible



Use an infrared camera, an ultraviolet (UV) light, a magnifying glass, and a magnetic field detector to reveal the information that's not visible to our human eyes.

Stools feature beautiful images of the planets in our solar system.

Electrical Requirements: 5.18 Amps



# Assembly and Installation

This component is operational as it is. It needs only to be plugged in. It comes with a set of four starter tiles and a set of four backup tiles.

Note: Be careful when lighting this exhibit. The effect of the UV light on the tiles is reduced in bright direct light.

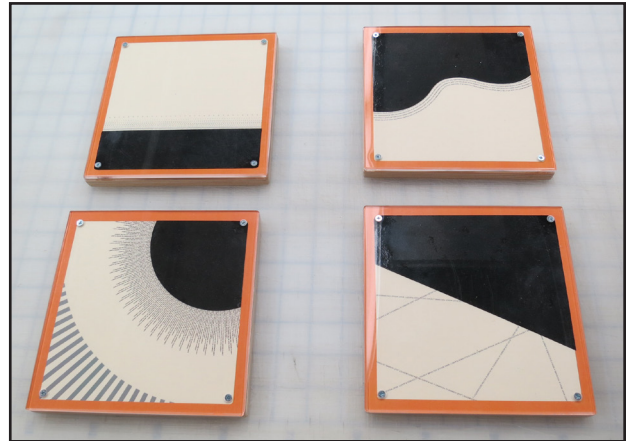

One set of tiles includes these four designs. Put one set on the floor and hold one set in reserve until needed.

## Hardware and Electronic Components

Component	Component Description	Vendor	Vendor Order #	Amp Draw
IR Camera	Speco HD2462-12V5MA 1080P Dome camera, Gray	CCTV Camera World		0.05
Monitor	Speco M19LED	CCTV Camera World		5
Magnifier and Light	AmScope LED-64-A Microscope Ring Light Illuminator with Dimmer	Amazon		0.08
UV Power Supply	Bestcompu AC DC 5V 1A Adapter Charger P/N SDK-0302 Switching Converter Power Supply Cord	Amazon		0.05
UV Bulb	3.5V 300mA UV LED	Digikey	1125-1254-ND	-

# Your Mission to Space Board Game



Put all your new space mission-planning knowledge to the test by playing this board game. Will your mission be the first to be completed? What will you discover?

Electrical Requirements: None

## Assembling the Exhibit

This component requires the 16" legs to be attached. Use four 1/4" x 1-1/4" lag screws per leg, as with the Design/Build/Test component. See page 13.

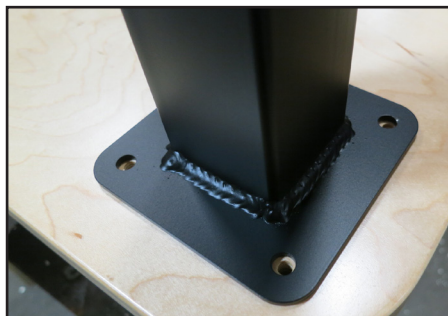



# Mars Landscape Play Table

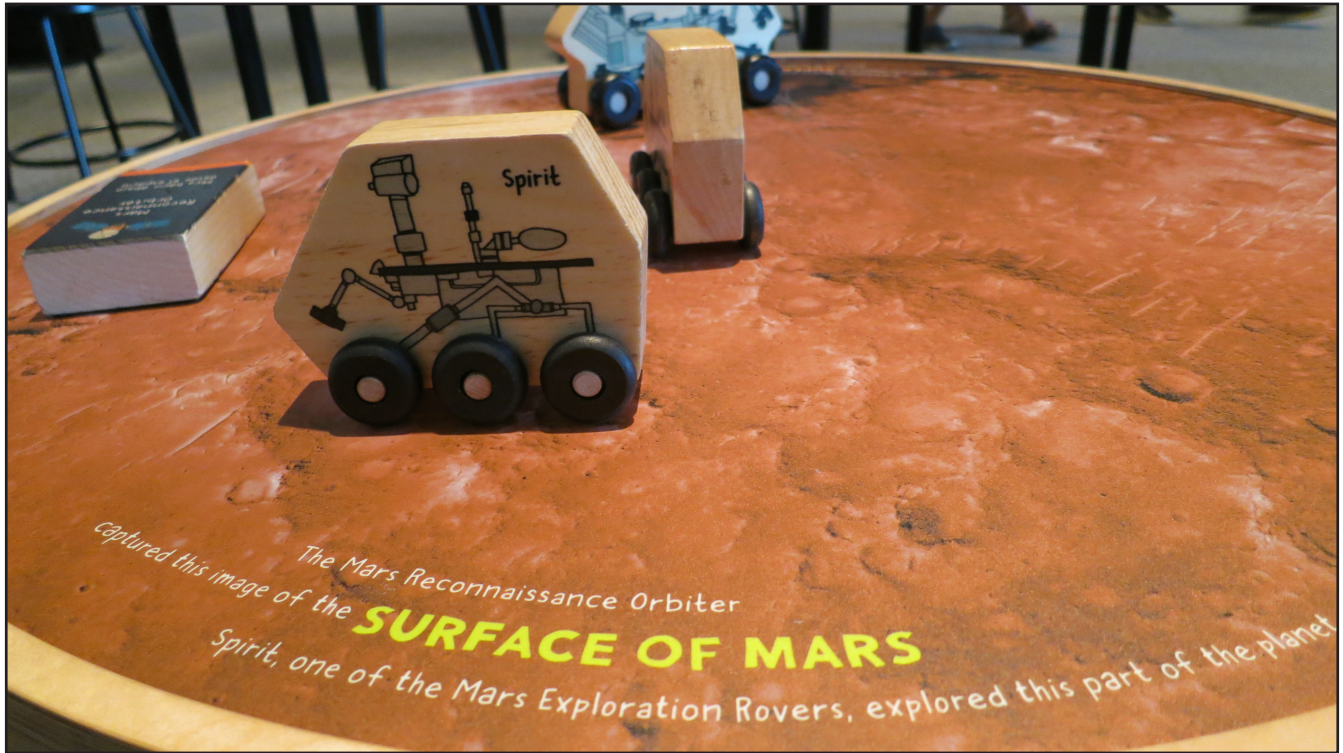

Little scientists use imaginative play while exploring the surface of Mars with toy rovers and spacecraft.

Electrical Requirements: None

## Assembling the Exhibit

This component requires the 16" legs to be attached. Use four 1/4" x 1-1/4" lag screws per leg, as with the Design/Build/Test component. See page 13.

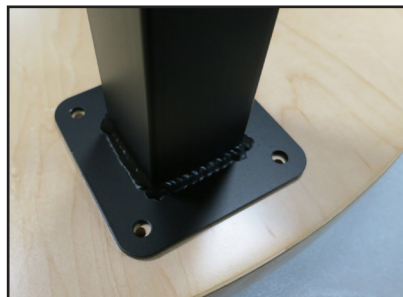



# We Ask Questions About the Earth

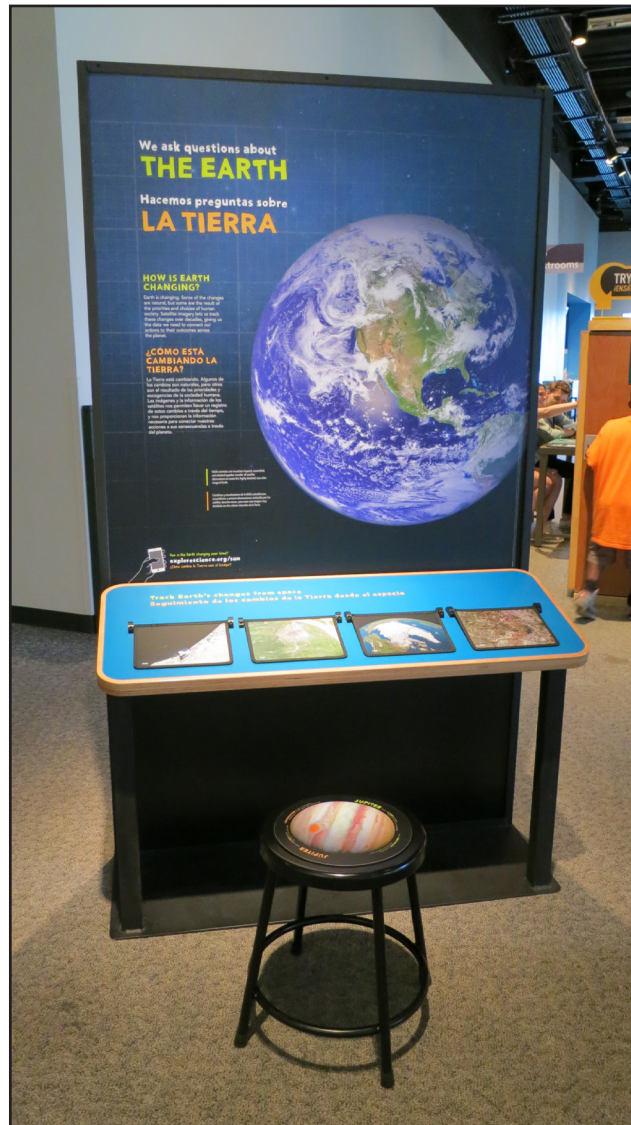

How is Earth changing? Compare before and after satellite images of Earth to see how human-caused actions impact our home.

Electrical Requirements: None

This component needs no assembly.

# We Ask Questions About the Sun



How do storms on the Sun impact Earth? Compare images that show the Sun at periods of high activity, called the solar maximum, and periods of low activity, the solar minimum.

Electrical Requirements: None

This component needs no assembly.

# We Ask Questions About the Solar System



What is it like on other planets? Use colored blocks to create a topographic map of elevations on Venus to learn how scientists use color to visualize data.

Electrical Requirements: None



# Assembling the Exhibit

This exhibit will come with two boxes of “Pixel Pegs”- colored wooden blocks that represent colored pixels that in turn represent data.

There is a starter box that includes:

211 purple pegs

125 blue pegs

90 green pegs

50 yellow pegs

90 orange pegs

Place the contents of the starter box in the bin.

There is also a box containing a generous number of spares.

# We Ask Questions About The Universe

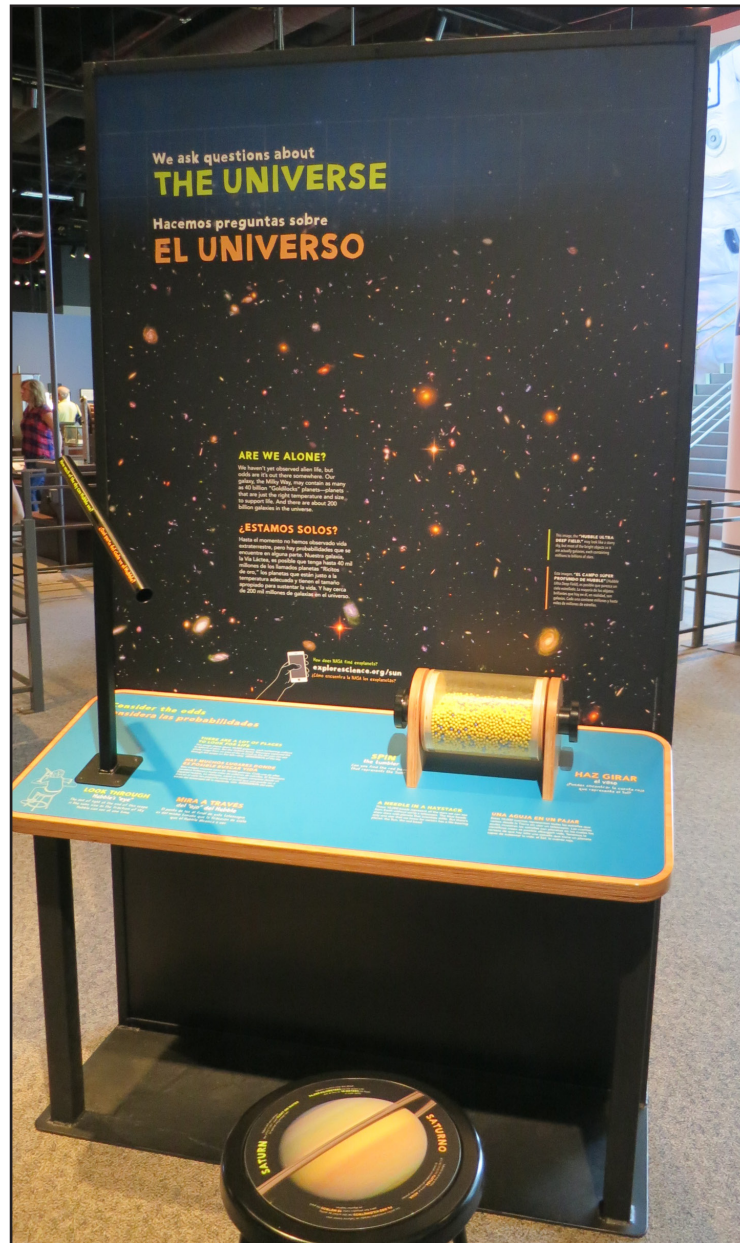

Are we alone? Spin a tumbler of 10,000 beads, representing all of the stars we can see from Earth to search for the unique one that represents our Sun.

Electrical Requirements: None

# Assembling the Exhibit

The component was shipped with the “Hubble Eye” scope packed separately. Use four black oxide 1/4-20 x 3/4” cap screws to connect the scope to the reading rail, and use a 5/32” Allen wrench to drive the screws. The screws have been wrapped in stretch wrap around the scope. Thread each screw in a few turns before tightening them all. The scope will be more effective if the component is placed so the scope is pointed toward a light source.

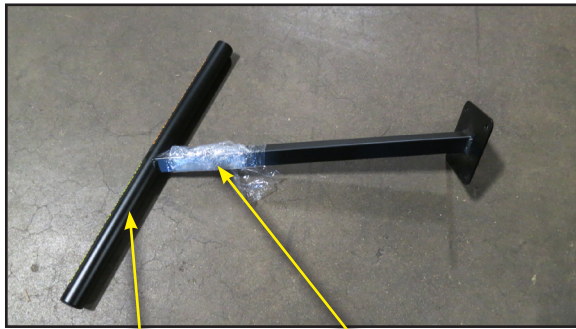

Scope

Stretch Wrap, with Screws

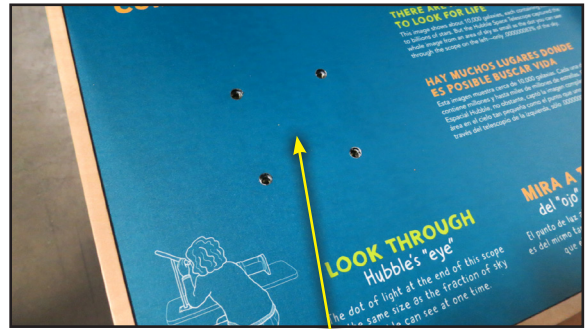

Scope Mounting Spot  
with Threaded Inserts

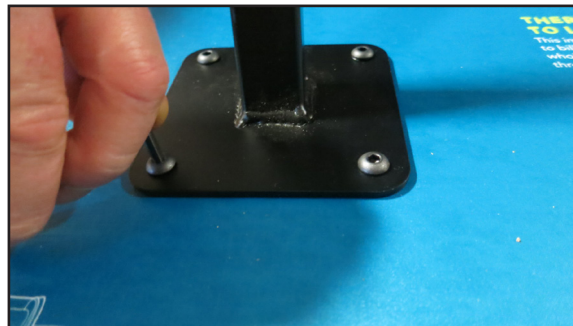



# Recommended Floor Plans

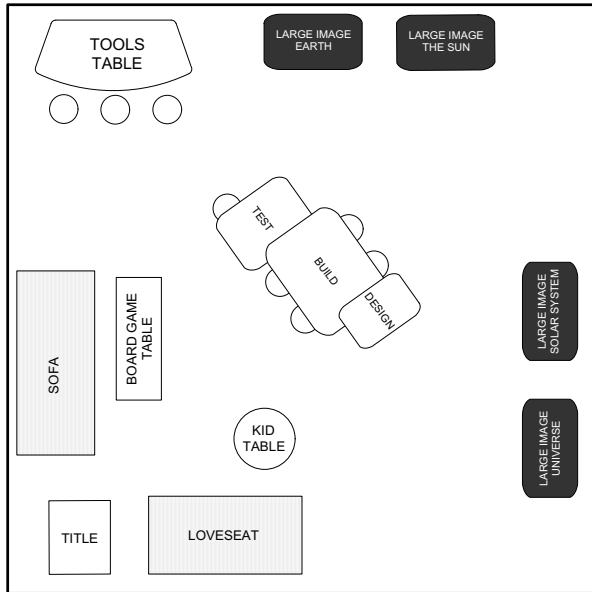

Square Space

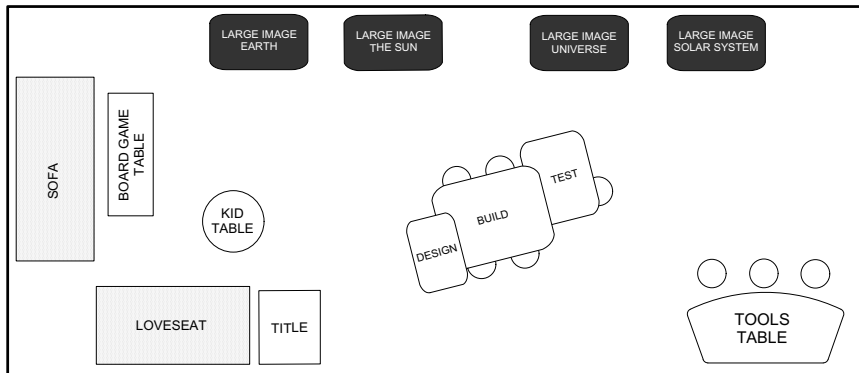

Rectangular Space

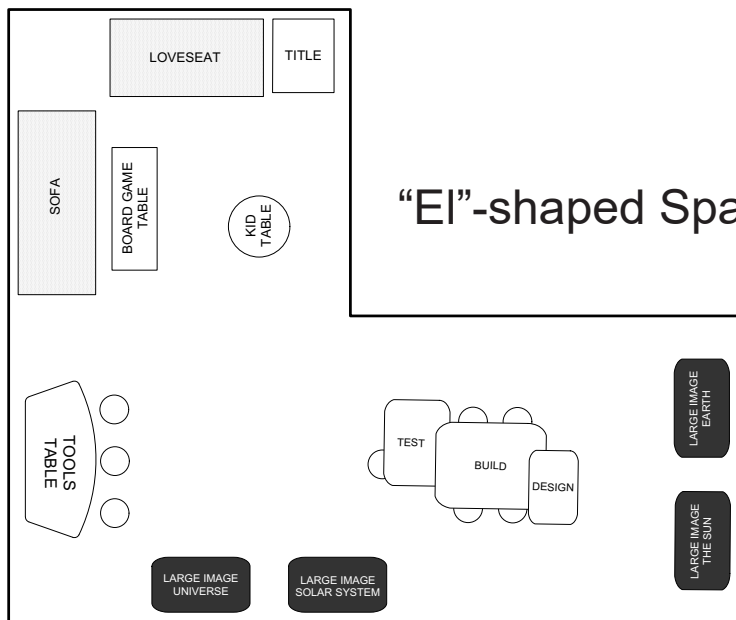

“EI”-shaped Space

# Maintenance and Troubleshooting

## General Cleaning

**Note: Do not use alcohol or any other solvent on any surface.**

### Graphics and Wood Surfaces

Recommended products include dish soap and water, Simple Green, and Formula 409.

Tip:  
Spray the cloth, not the surface. Especially when cleaning graphics it is important to remember to spray the cloth, not the surface being cleaned. Spraying the surface can lead to excess cleaner running into cracks and spaces. This can lead to graphic edges bulging and peeling, adhesive losing its properties, and buildup of rust under hardware.

### Plexiglas Vitrine for Design/Build/Test and the Universe Bead Jar

Recommended products include Novus 1 and Spartan Renewables Glass Cleaner.

**Do NOT use Windex or Formula 409. They contain solids that will scratch plastic.**

As with the wood and graphic surfaces, spray the cloth and not the surface.

### Foam Model Parts for Design/Build/Test

A fabric mesh bag has been supplied to use when cleaning the gray foam model parts. Place parts in the mesh bag, zip it shut, and wash on the gentle cycle of a washing machine using a small amount of laundry detergent. Air dry, or dry using a no-heat cycle only.

### Sofa and Love Seat

The covers of the sofa and love seat are machine washable (hang to dry), or in the case of permanent stain, replaceable. Replacement covers are available at Ikea.

# Use Tools to Detect the Invisible

## Access to the Backs of the Cabinets

For most troubleshooting on this component it will be necessary to remove the back panel in order to get access to the back side of the individual cabinets. Unplug the power strip at the back of the exhibit from the wall. Unplug the cords from the power strip. Remove the three bolts attaching the large back graphic panel to the table top. The center bolt is recessed behind the cable cover and may need a deeper socket. Carefully set the panel aside. You now have access the metal mesh shields. Remove the shields by removing the screws holding them in place. Be careful handling the shields; they are vulnerable to getting bent.

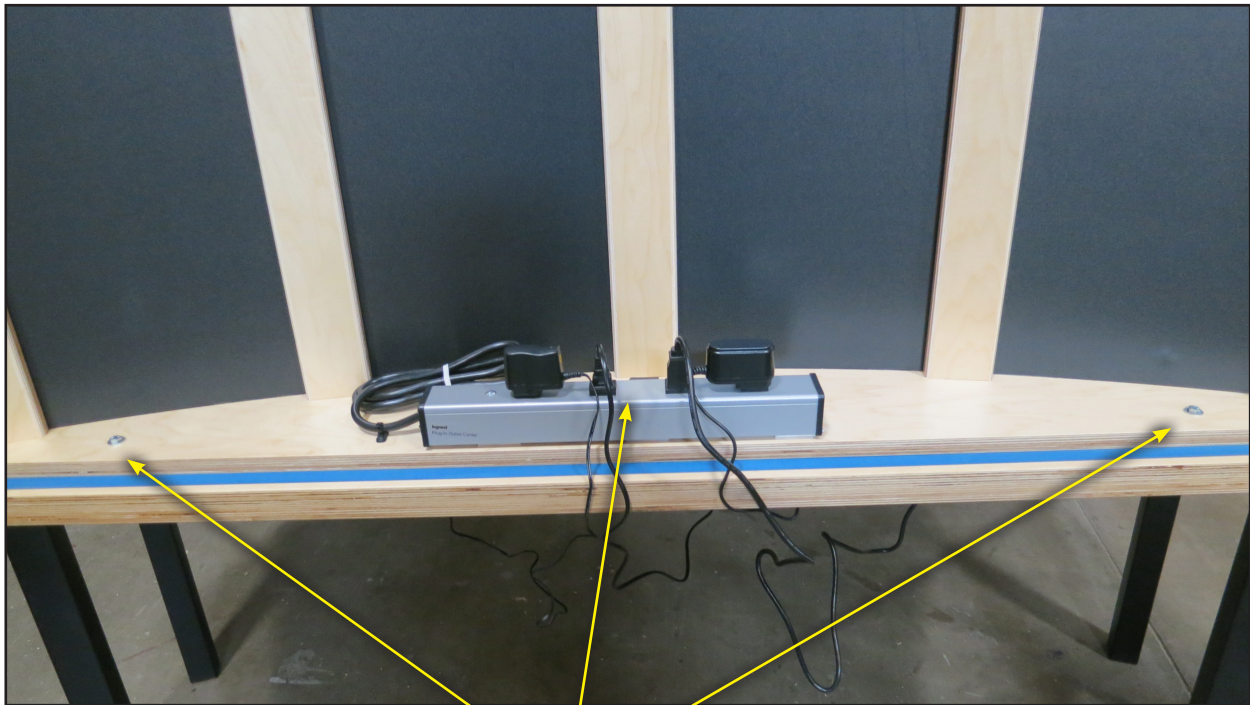

*Bolts  
(One is behind Power Strip)*



## Magnifier and Light

### Setting the Light Level

The light level has been pre-set to 4.5. If a different setting is desired, remove the back graphic panel, as above, and change the setting.

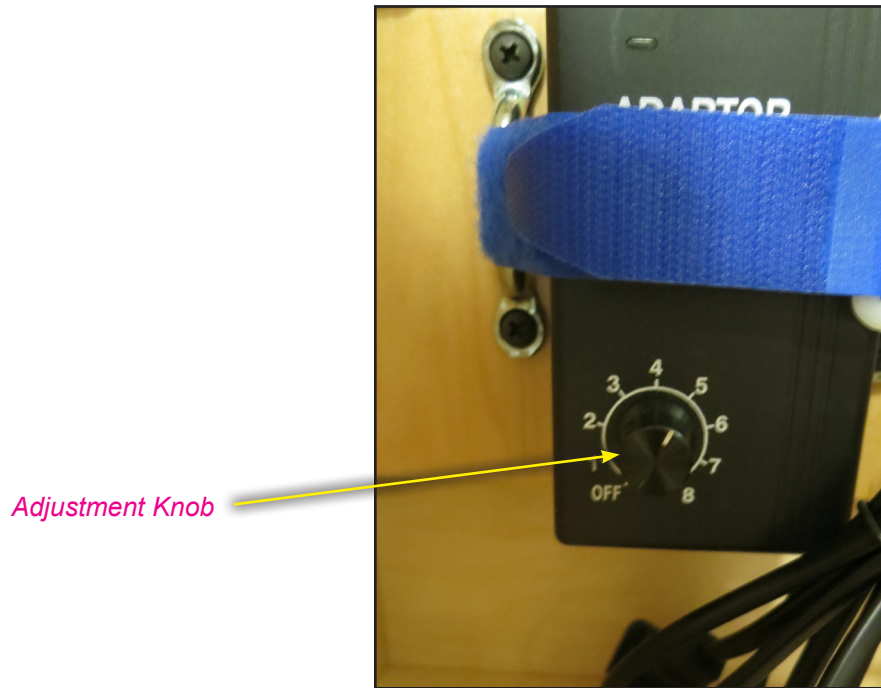

## Infrared Camera Monitor Power

### Turning on the Monitor

This can be done without removing the back cover. If the monitor inadvertently gets turned off, it can be turned back on again using the remote control. Point the remote control at the back side of the monitor, through the mesh screen, and press the "on" button.

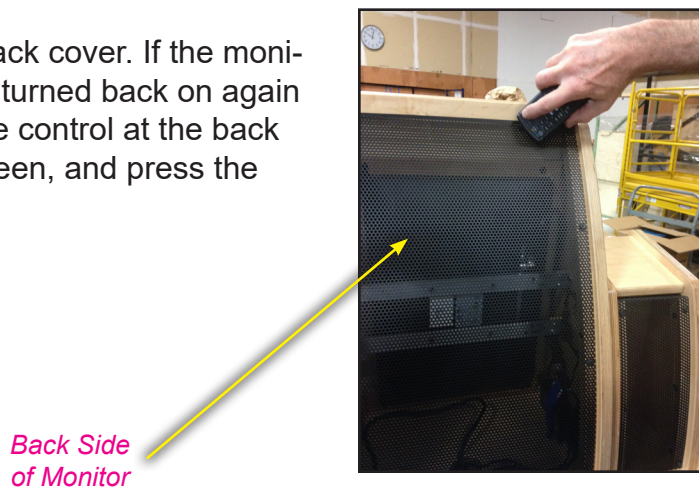

## Infrared Camera

### Adjusting the Camera Focus

The camera lens is locked into place so the focus is directly on where the tile is placed. If the camera gets mis-adjusted, it can be readjusted. The Allen wrench needed is stored inside the casing behind the camera. Remove the mesh screen to get access.

Loosen the set screw and rotate the housing enough so the camera can be moved. Adjust it so it is properly focused on the tile and re-tighten the lens. Tighten the housing so the set screw faces forward, and tighten the set screw.

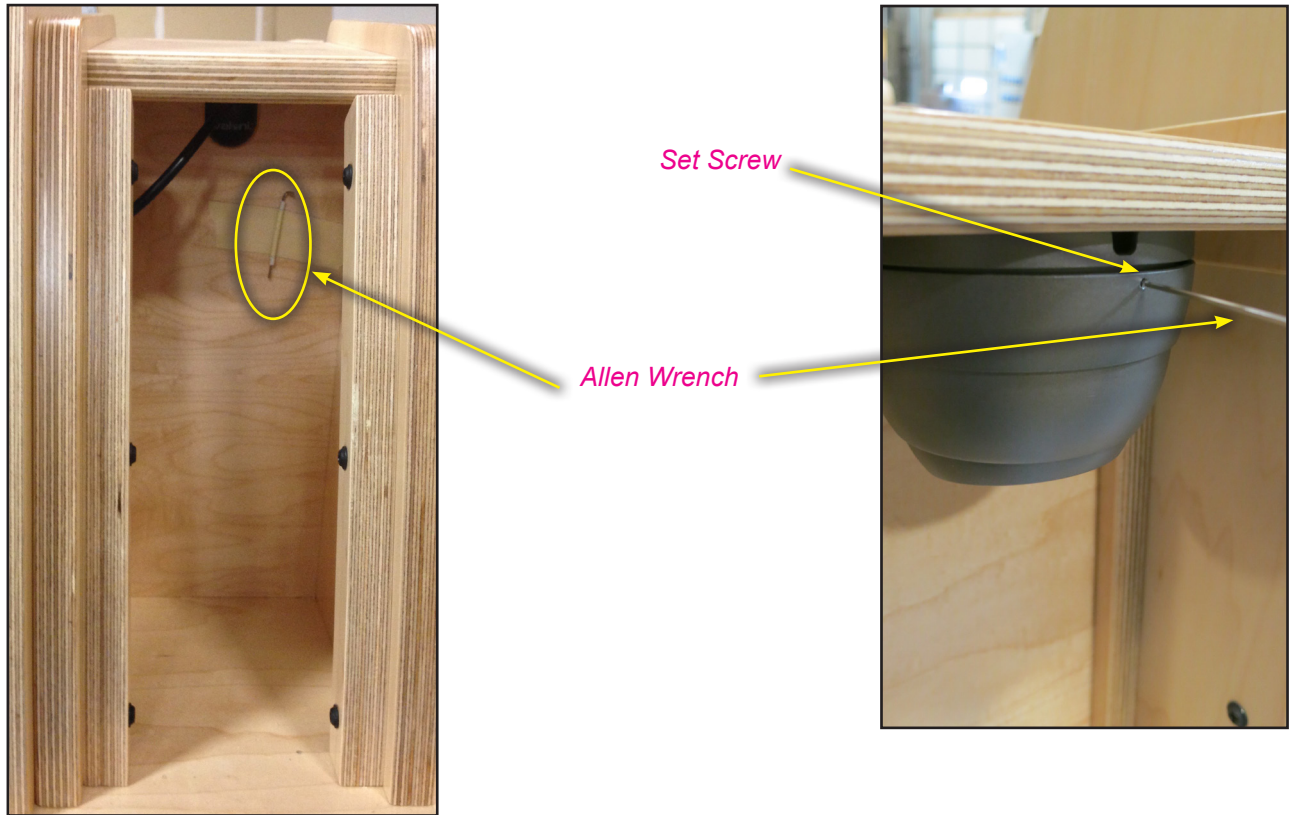

### “Video Loss” Onscreen Message

If you get this error message, first check the power plugs behind the curved graphic panel. Power cycle the power strip.

If that does not work, remove the metal mesh shields for the camera and monitor. Check that there is power to the camera, and check that all cables between them are firmly connected.

# Design/Build/Test

## Cleaning the Vitrine and Model Parts

Clean the vitrine with a non-solvent-based cleaner as needed.

A fabric mesh bag has been supplied to use when cleaning the gray foam model parts. Place parts in the mesh bag, zip it shut, and wash on the gentle cycle of a washing machine using a small amount of laundry detergent. Air dry, or dry using a no-heat cycle only.



Mesh Bag

## Replacing the Hook and Loop Straps

When the hook and loop straps wear out they will need to be replaced. A starter stock of extras has been provided. A ten-foot length of double-sided hook and loop is available from McMaster-Carr, part number 94905K833. Cut the strap into 18" lengths. Using the hole punch provided, punch two 5/16" holes in the strap, one 8" from the end and the other 10" from the same end, and centered vertically.

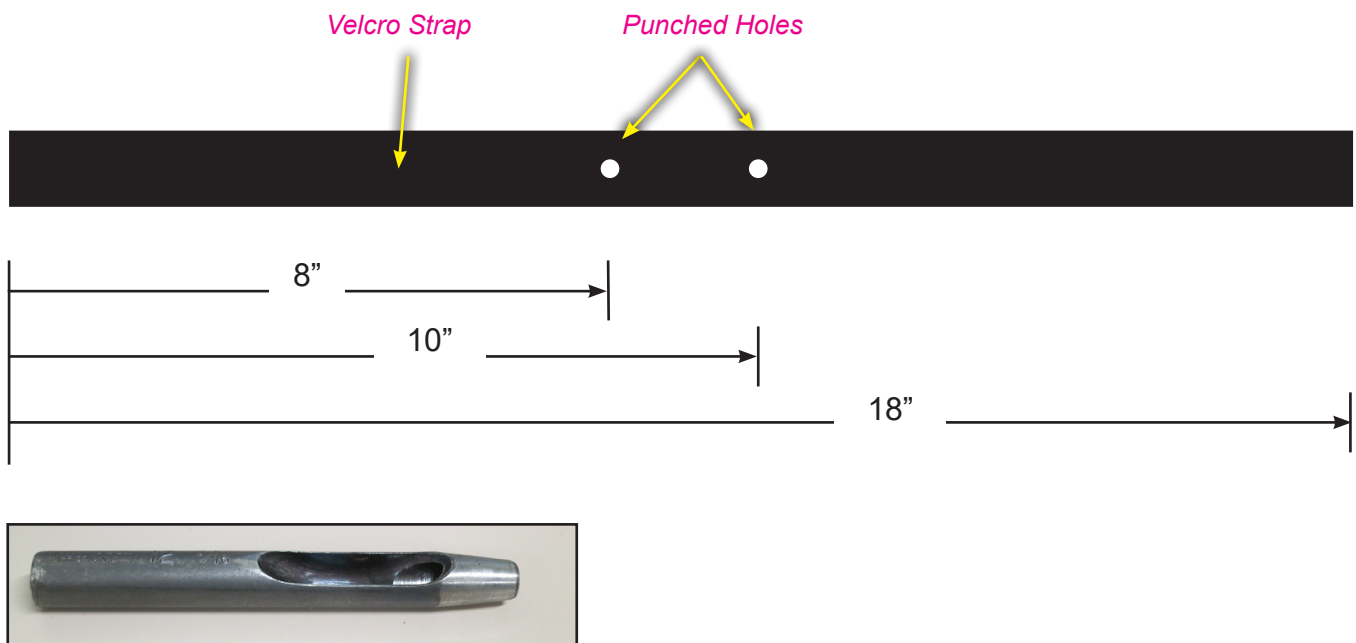

Hole Punch



### Shake Test

The process for the shake test and the spin test are similar but not identical. The tool needed for the shake test is a 5/32" Allen wrench. Loosen the two screws to the side of the strap about 3 turns.

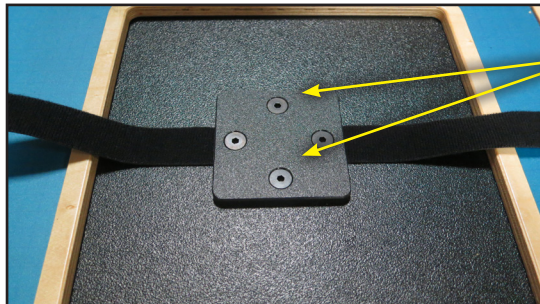

Side Screws

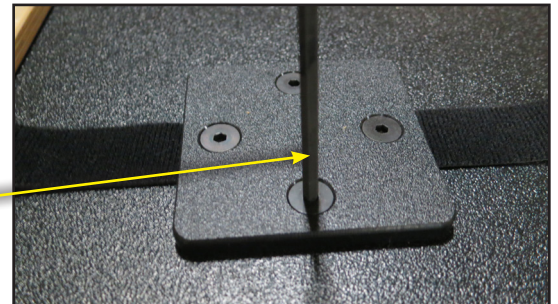

Allen Wrench

Completely remove the two screws that pass through the strap. The old strap can now be removed.

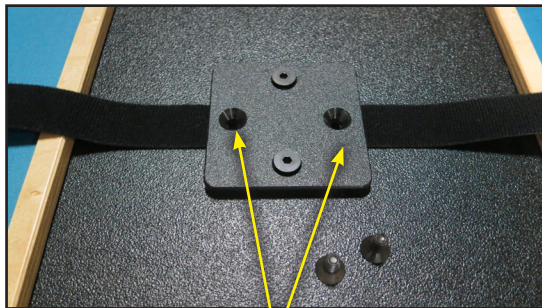

Strap Screws

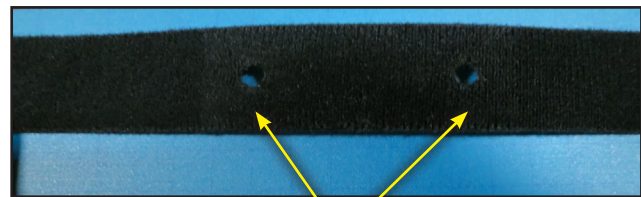

Replacement Strap with Holes

Slide the new strap into the slot in the top plate, fuzzy side up, aligning the holes in the strap with the holes in the plate. Thread both screws back through the plate and the strap. Hand-tighten all four screws.

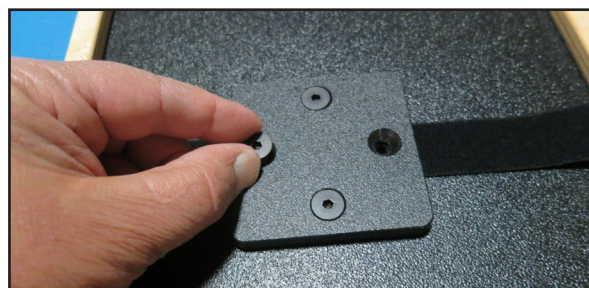
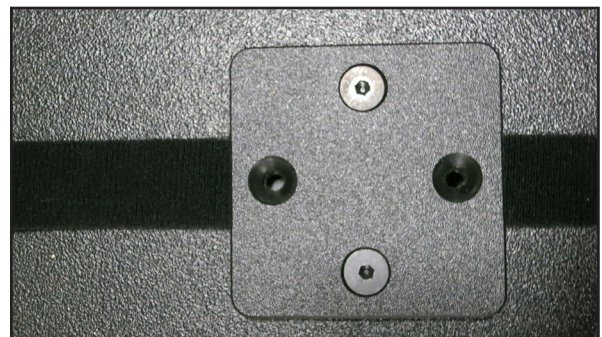
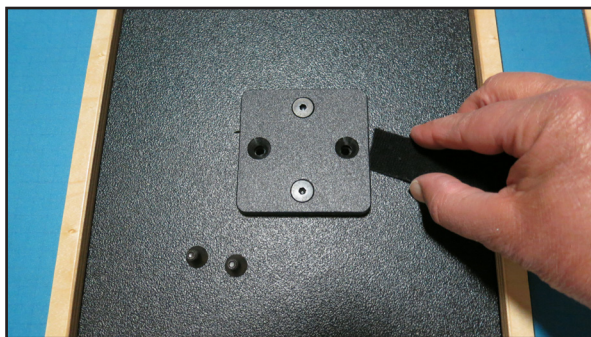



### Spin Test

The tools needed for the spin test are a 7/16" box wrench, a 5/32" Allen wrench, and a screw gun. Under the bench below the spinner you will see four screws. Remove the two screws closest to the front of the bench. Remove the plywood arc below the front of the spinner and set it aside. The nuts for the screws securing the plastic plate are now accessible.

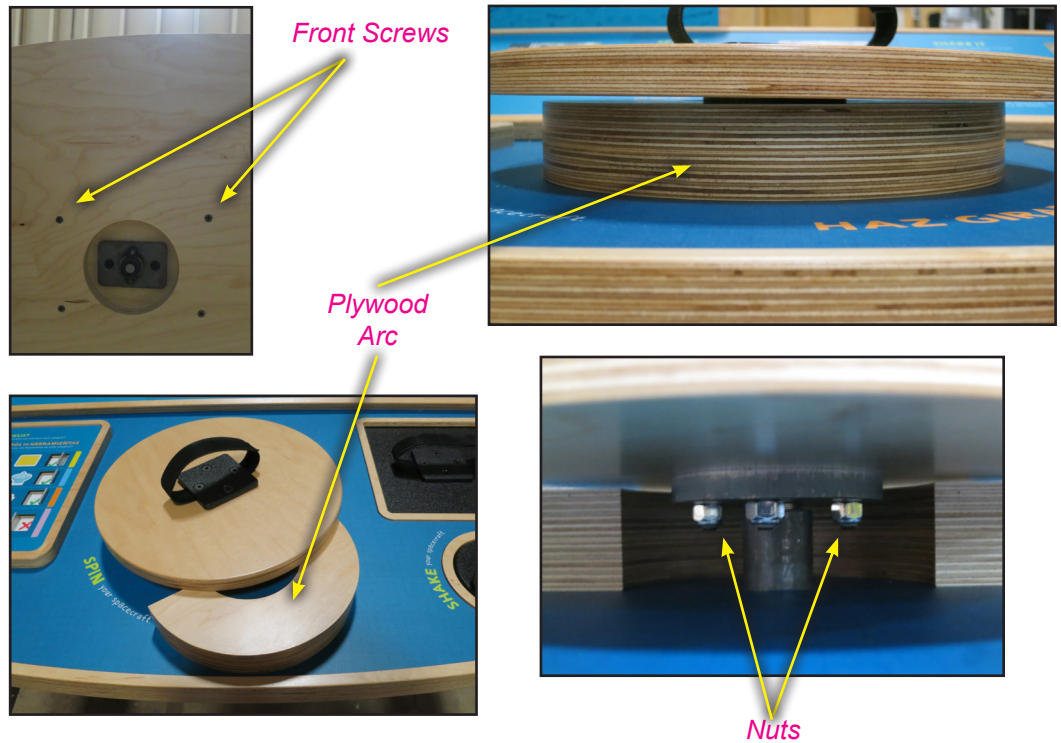

Using the box wrench and Allen wrench, loosen the two screws to the side of the strap about 3 turns. Completely remove the two screws that pass through the strap. The old strap can now be removed. Slide the new strap into the slot in the top plate, fuzzy side up, aligning the holes in the strap with the holes in the plate. Replace both screws back through the plate and the strap. Using the open end of the box wrench and your finger, hold the nut under the screw and get the threads started. Repeat this for the other screw. Hand-tighten all four screws. Replace the plywood arc.

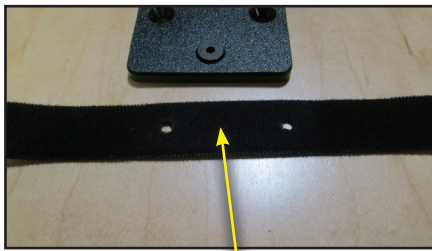

Replacement Strap with Holes

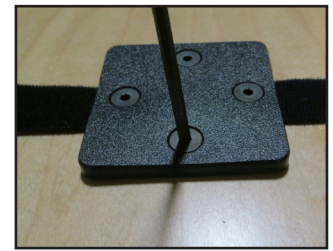
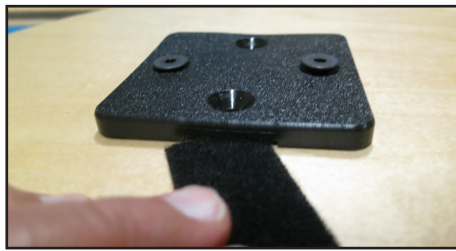

It can be challenging to reconnect the screw to the nut. Putting a piece of masking tape in the wrench can help keep the nut in alignment as you thread it to the screw.



## Re-Seating the Shaker Belt

If the shake test mount does not move when the crank is turned, the interior belt has either slipped off a pulley or broken. On the bottom side of the shaker is a plywood plate. Mark the edges of the plate with masking tape to help with alignment later. Remove the seven screws securing the plate in place. Carefully hold the plate in place until the last screw has been removed.



*Plywood Plate with Masking Tape Marks*

*Shake Test Mount*

*Screws*

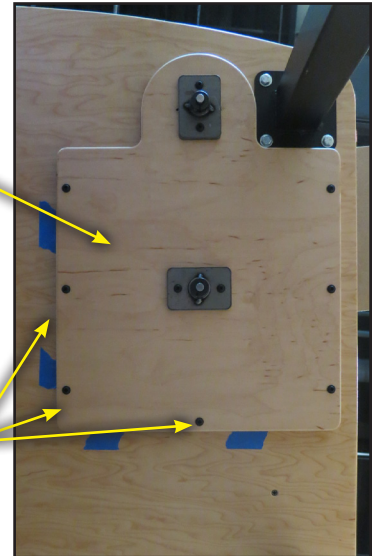

Lift the shake test mount off of its peg. If the orange belt is intact, stretch it and restore it to the grooves in the pulleys. If it is broken, replace it.

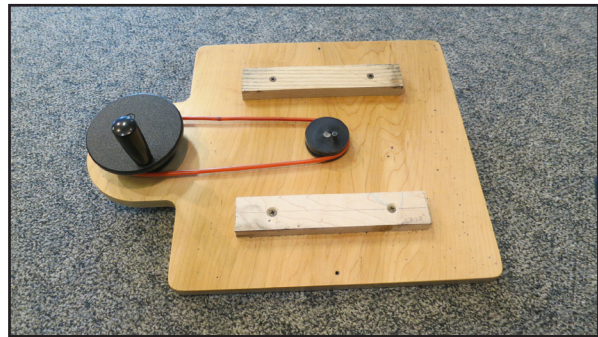
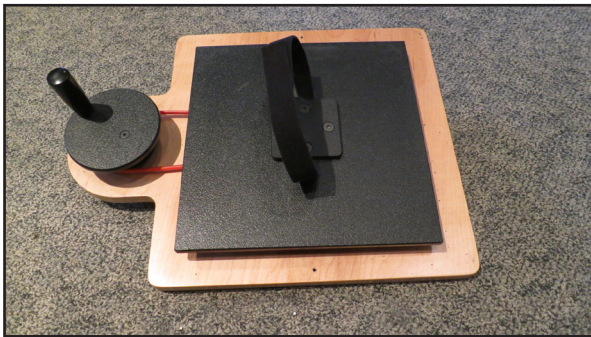

*Shake Test Mount Peg*

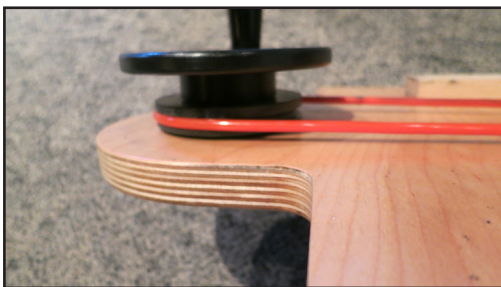

*Orange Belt Properly Seated in the Pulleys*

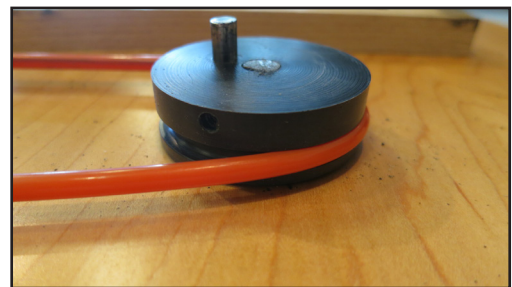

Put the mount back on its peg so the hook and loop strap is oriented as in the photo. Use the masking tape to help align the plate, and drive the screws back into the holes.



# Replacing a Flip Book Page

If a flip book page gets damaged it will need to be replaced. The replacement process for this component is different from the other flip books in the exhibit.

Remove the two washer head screws from the side of the plywood triangle. Remove the two flat head screws from underneath the table. The triangle can now be moved and the page replaced. Remove the hinge (1/8" steel welding rod) from the old page and slip it into the new one. Note the orientation of the original page before replacing it. Drive in the two washer head screws first, then replace the flat head screws.

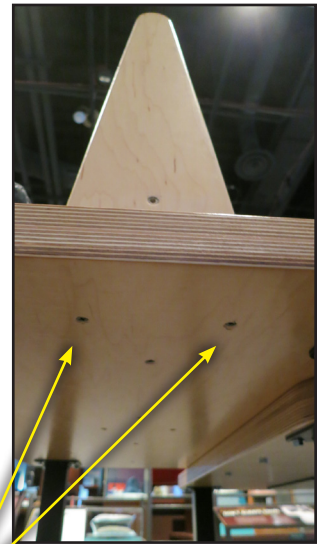
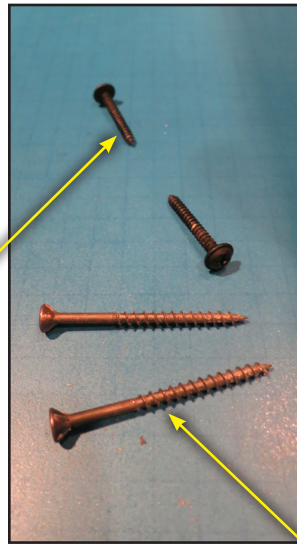
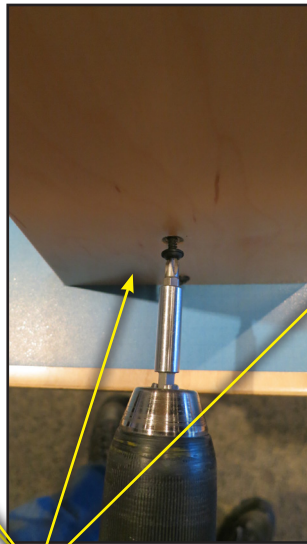

Washer Head  
Screws

Flat Head  
Screws



# Flip Book Replacement, General

Flip book pages may wear out or get damaged and need replacement. Flip books, except for Design/Build/Test, are essentially the same. To replace a page one of the plastic hubs must be removed. Use a screwdriver to remove the two screws securing the hub.

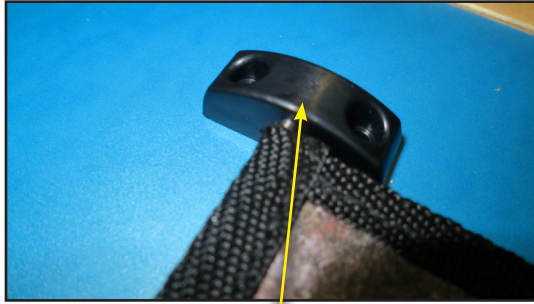

*Hub*



Set the hub aside and release the hinge. Remove the hinge (1/8" steel welding rod) from the old page and slip it into the new one. Return both ends of the hinge into the hubs and replace the screws. Be careful not to over-drive the screws.

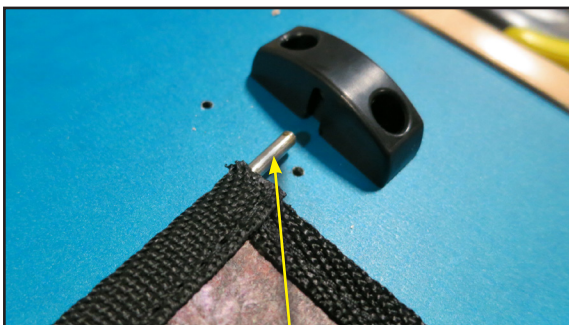

*Hinge*



# Miscellaneous

## Hardware

Over time, some hardware may wear out or become lost. Listed below are some of the most important items and where to get them.

Item	Item Description	Usage	Vendor	Vendor Order #
Lag screws	1/4" x 1-1/4"	Attach legs to table tops	Hardware store	
Hex bolts	1/4"-20 x 2"	Connect Design/Build/Test tables	Hardware store	
Black oxide button-head cap screws	1/4"-20 x 3/4"	Connects graphic and "Hubble Eye" to tables.	McMaster-Carr	91255A540
Black oxide button-head cap screws	1/4"-20 x 3/4"	Connects vitrine to base	McMaster-Carr	91255A540
White nylon bushings	0.313" high	Connects vitrine to base	McMaster-Carr	91145A165
Black oxide flathead screw	1/4"-20 x 1/2"	Connects Velcro clamping plate to "shake" test	McMaster-Carr	91253A537
Black oxide flathead screw	1/4"-20 x 1-3/4"	Connects Velcro clamping plate to "spin" test	McMaster-Carr	91253A548
Nylon insert lock nut	1/4"-20	Connects Velcro clamping plate to "spin" test	McMaster-Carr	95615A120
Welding Rod	1/8" diameter Cut to length	Flip book hinges	McMaster-Carr	7972A454
Velcro Straps	1" wide, 10' long	"Shake" and "Spin" tests	McMaster-Carr	94905K833
Key	C390A	Bookcase	McMaster-Carr	1770A213



# Finishes

## **Solar System Pixel Pegs:**

Orange	PMS 165
Yellow	PMS Yellow C
Green	PMS 368
Blue	PMS 300
Purple	PMS Violet C

## **Board Game Tokens:**

Purple	PMS 2655C
Yellow	PMS 7548C
Blue	PMS 310C
Green	PMS 2298C

## **Powder-Coat for Steel:**

Solar Black

## **Wood:**

Two-part satin clear coat

# Repacking

If the exhibit needs to be moved to another location, care will need to be taken to protect it from wear and tear during shipping. The components will be packed differently than when they first arrived. A box of six packing blankets has been provided to use as needed. Extra ratchet straps have also been provided.

We do not recommend removing any legs from their table tops.  
Do not disassemble the sofa or love seat.

## Repacking Basics Ratchet Straps

The exhibits will be need to be tied down to the pallets with ratchet straps. A few basic rules will enable you to do this safely and securely.

The ratchet straps you have been provided with come in two parts. One is a long strap with an s-hook on one end. The other is the ratchet.



*Strap with s-hook*

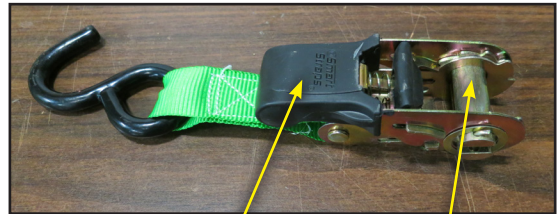

*Ratchet*

*Center Pin*

The center pin in the ratchet has a slot. Open and close the ratchet until the slot is oriented as in the lower left photo. Thread the free end of the strap through the slot in the center of the pin and back around the outside of the pin. Open and close the ratchet to rotate the pin. The pin will pull the strap into the ratchet, eventually locking it in place. The ratchet strap is now ready to use.



*Slot*



*Free End*



Exhibit surfaces will need to be insulated from the straps, or friction during shipping will damage them. Use packing blankets or packing corners to protect all surfaces. If desired, cardboard packing corners, stretch wrap, and other packing materials are available from Uline.

*Strap with Packing Corner*



Ratchet straps can be attached to the pallet with eye bolts. They can also wrap around and thread through the upper layer of the pallet and back up the other side, with the S-hooks connecting. When threading straps through pallets be careful to go through the top deck only. Strapping through the openings for the fork lifts or below the bottom layer will expose the straps to damage.



*Strap in Eye Bolt*



*Strap Through Pallet*



*Fork Lift Opening*

Straps that thread through the pallets will need to have the s-hooks linked together. Link them so each open end links into the closed end of the other hook. If the open ends only are linked the connection is less secure. Excess strap should be tied off and kept out of the way.

*Properly Linked Straps Ends*





## Packing Tips

Most ratchet straps are 10 feet long. There are two extra long straps. Use one on the bookcase and the other on the “Tools” table.

Pallet #1, containing the Tools Table, has pockets built into the deck to fit the feet of the exhibit. They help keep it from shifting during transportation.



Sealed boxes can be placed underneath tables or on the back side of stanchions, and secured with stretch wrap. Sheets of corrugated cardboard can insulate boxes from graphic surfaces.

The “Mars Play” table and the “Board Game” table can be shipped upside down, with sufficient padding to protect the table tops from the pallets.

Remove the “Design/Build/Test” vitrine and model, and pack them into their boxes. Also remove the circular graphic. Save all hardware in a container or plastic bag.

After disconnecting the “Design/Build/Test” tables, put the hardware, remote control, bookcase keys, and manual back in the red “Open First” box.

Two of the “Design/Build/Test” tables will have only three legs and will be the most difficult items to pack. Try to find solid objects to pack them against. Do not strain the leg/table connections and do not have any parts overhanging the outsides of the pallets.