

THE INFORMATION CONTAINED IN THIS DRAWING IS THE SOLE
 PROPERTY OF OMSI. ANY REPRODUCTION IN PART OR AS A
 WHOLE WITHOUT THE WRITTEN PERMISSION OF OMSI IS PROHIBITED.
 5/18/2009 UNLESS OTHERWISE SPECIFIED:
 1 OF 6 DIMENSIONS ARE IN INCHES
 TOLERANCES:
 FRACTIONAL ±1/32"
 ANGULAR: MACH ±0.25° BEND ±1°
 TWO PLACE DECIMAL ±0.03
 THREE PLACE DECIMAL ±0.005

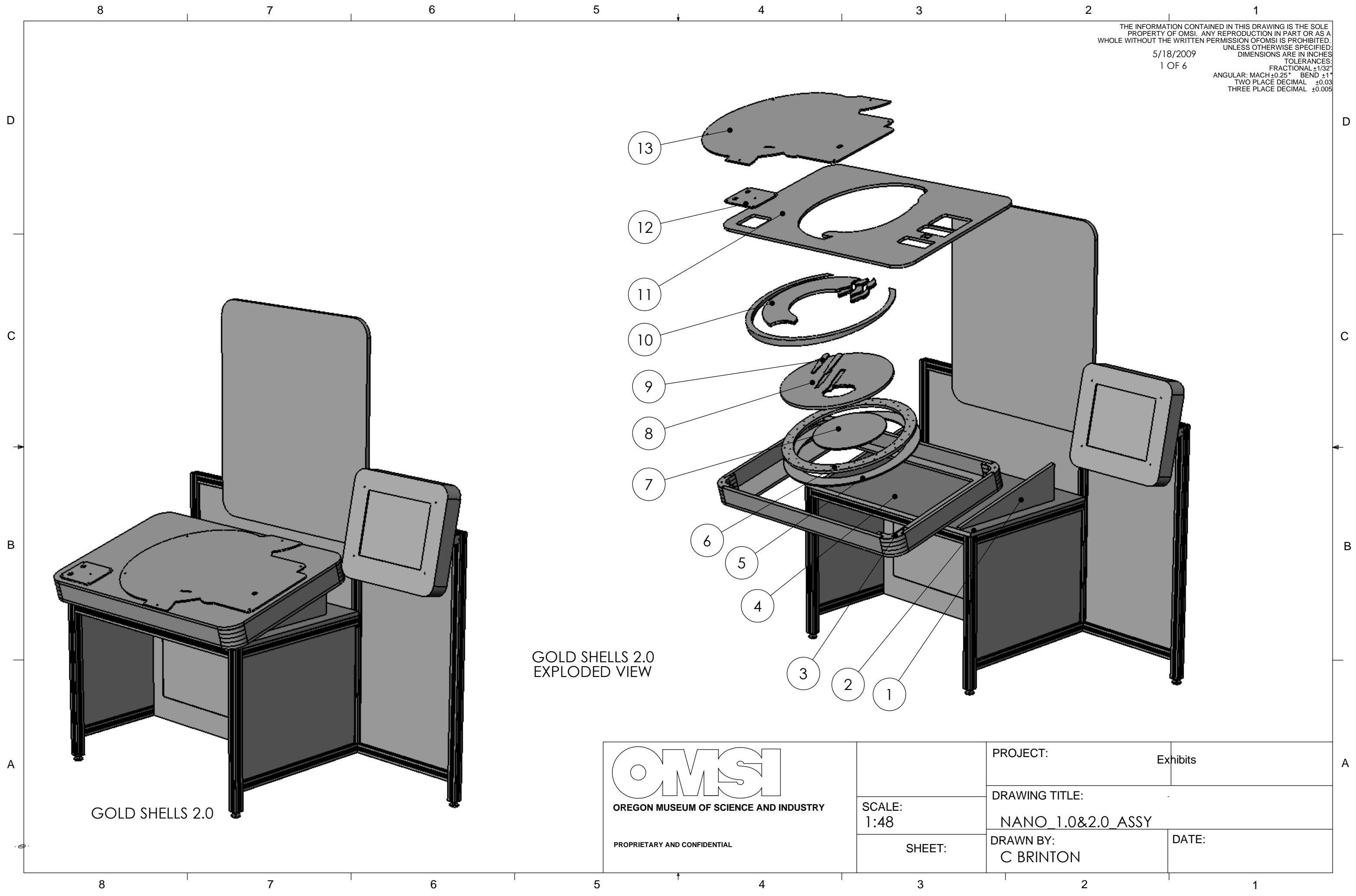

GOLD SHELLS 2.0
 EXPLODED VIEW

GOLD SHELLS 2.0

OMSI
 OREGON MUSEUM OF SCIENCE AND INDUSTRY
 PROPRIETARY AND CONFIDENTIAL

SCALE: 1:48	PROJECT:	Exhibits
	DRAWING TITLE:	NANO_1.0&2.0_ASSY
SHEET:	DRAWN BY:	DATE:
	C BRINTON	

8 7 6 5 4 3 2 1

REVISIONS				
ZONE	REV.	DESCRIPTION	DATE	APPROVED

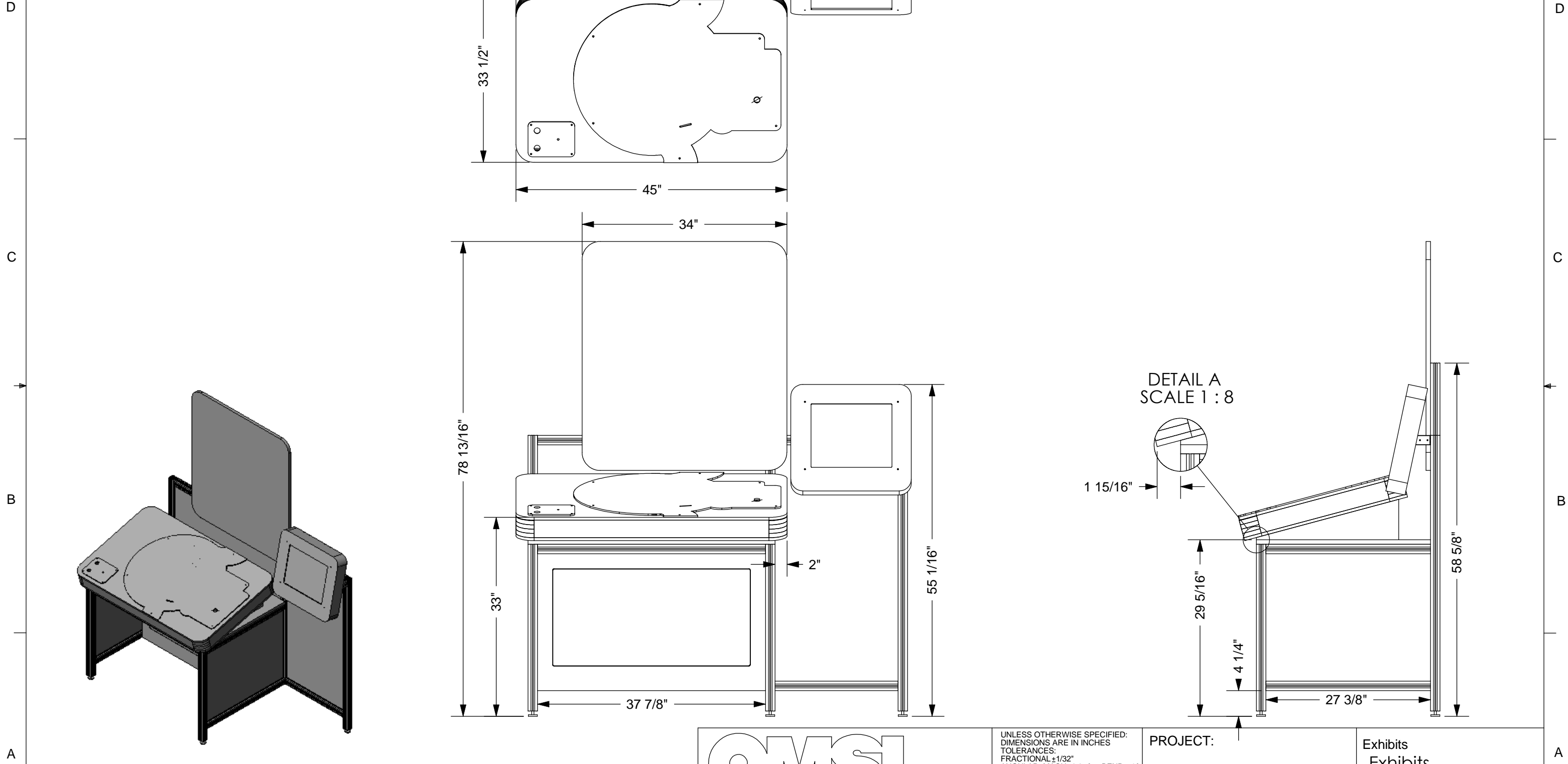

DETAIL A
SCALE 1 : 8

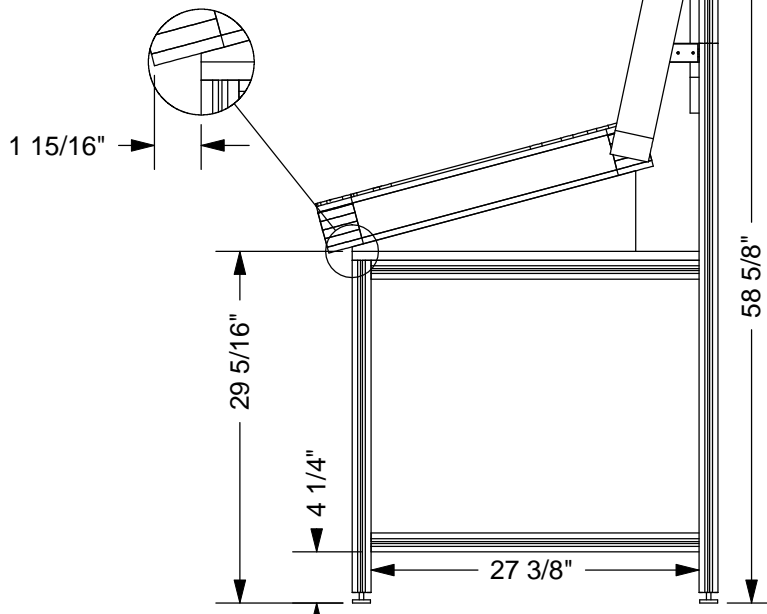

A

OMSI
OREGON MUSEUM OF SCIENCE AND INDUSTRY
 1945 SE WATER AVENUE
 PORTLAND, OR 97214-3354
 PH: 503.797.4000
 FAX: 503.797.4500
PROPRIETARY AND CONFIDENTIAL
 THE INFORMATION CONTAINED IN THIS DRAWING IS THE SOLE
 PROPERTY OF OMSI. ANY REPRODUCTION IN PART OR AS A
 WHOLE WITHOUT THE WRITTEN PERMISSION OF OMSI IS PROHIBITED.

UNLESS OTHERWISE SPECIFIED:
 DIMENSIONS ARE IN INCHES
 TOLERANCES:
 FRACTIONAL ±1/32"
 ANGULAR: MACH ±0.25° BEND ±1°
 TWO PLACE DECIMAL ±0.03
 THREE PLACE DECIMAL ±0.005

SCALE:
 1:24

SHEET:
 1 OF 1

PROJECT:
 Exhibits
 Exhibits

DRAWING TITLE:
 NANO_1.0&2.0_ASSY

DRAWN BY:
 C BRINTON

DATE:
 7/2/2009

8 7 6 5 4 3 2 1

THE INFORMATION CONTAINED IN THIS DRAWING IS THE SOLE
 PROPERTY OF OMSI. ANY REPRODUCTION IN PART OR AS A
 WHOLE WITHOUT THE WRITTEN PERMISSION OF OMSI IS PROHIBITED.
 5/18/2009
 3 OF 6
 UNLESS OTHERWISE SPECIFIED:
 DIMENSIONS ARE IN INCHES
 TOLERANCES:
 FRACTIONAL $\pm 1/32"$
 ANGULAR: MACH $\pm 0.25^\circ$ BEND $\pm 1^\circ$
 TWO PLACE DECIMAL ± 0.03
 THREE PLACE DECIMAL ± 0.005

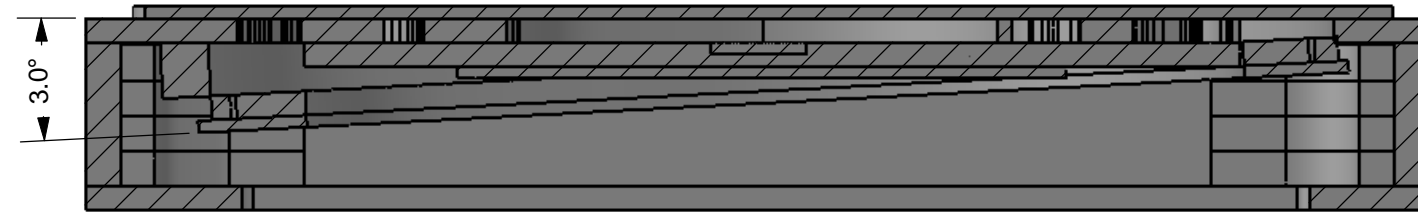

SECTION K-K
 SCALE 1 : 4

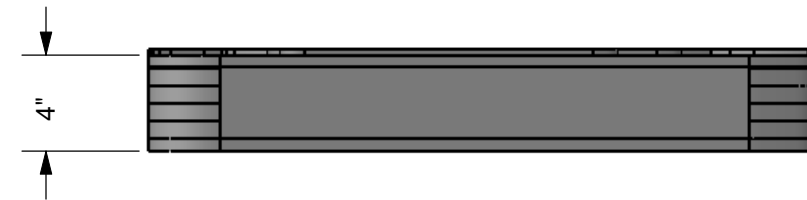
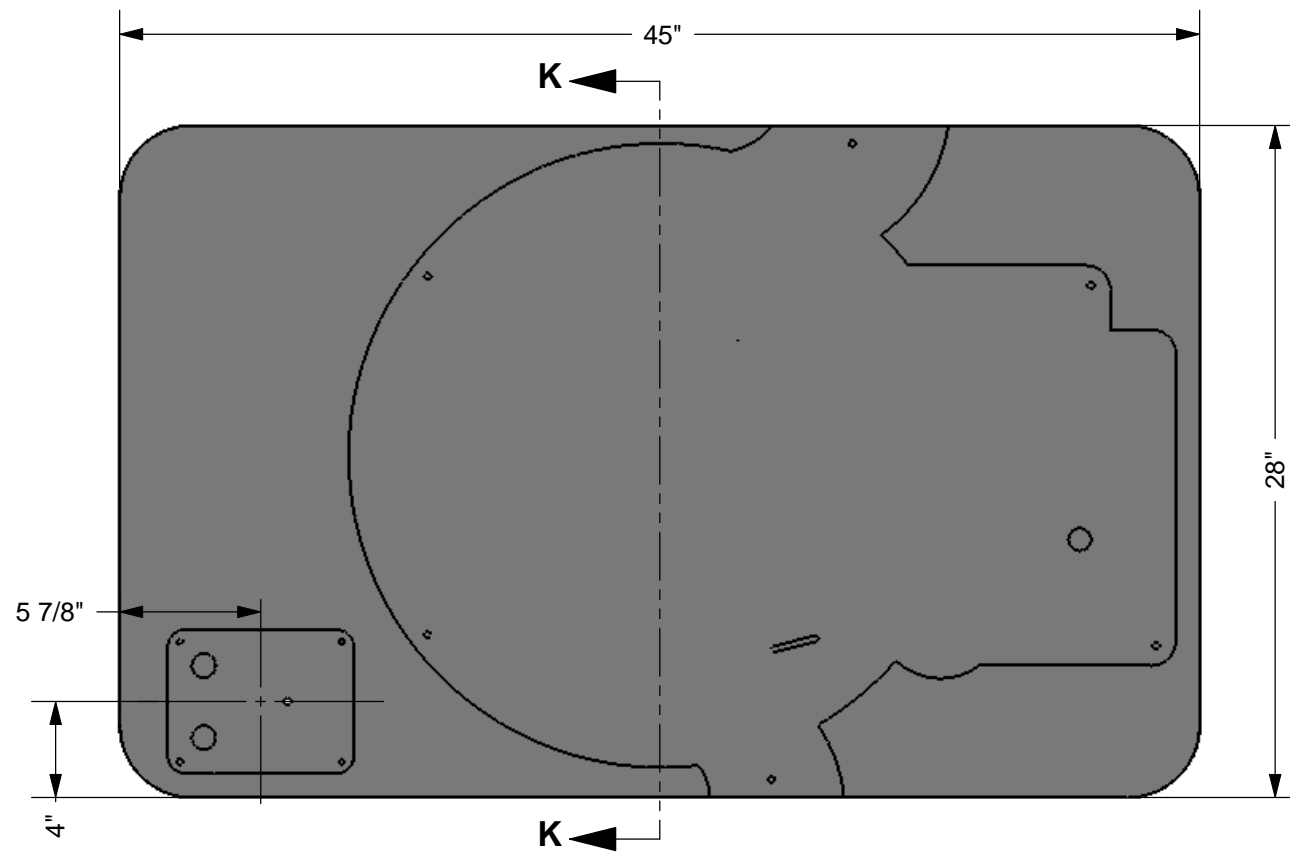

 OREGON MUSEUM OF SCIENCE AND INDUSTRY PROPRIETARY AND CONFIDENTIAL	SCALE: 1:48	PROJECT: Exhibits
	SHEET:	DRAWING TITLE: GOLD SHELLS ASSEMBLY
	DRAWN BY: C BRINTON	DATE:

THE INFORMATION CONTAINED IN THIS DRAWING IS THE SOLE PROPERTY OF OMSI. ANY REPRODUCTION IN PART OR AS A WHOLE WITHOUT THE WRITTEN PERMISSION OF OMSI IS PROHIBITED. UNLESS OTHERWISE SPECIFIED: DIMENSIONS ARE IN INCHES. TOLERANCES: FRACTIONAL ±1/32" ANGULAR: MACH ±0.25° BEND ±1° TWO PLACE DECIMAL ±0.03 THREE PLACE DECIMAL ±0.005

5/18/2009
4 OF 6

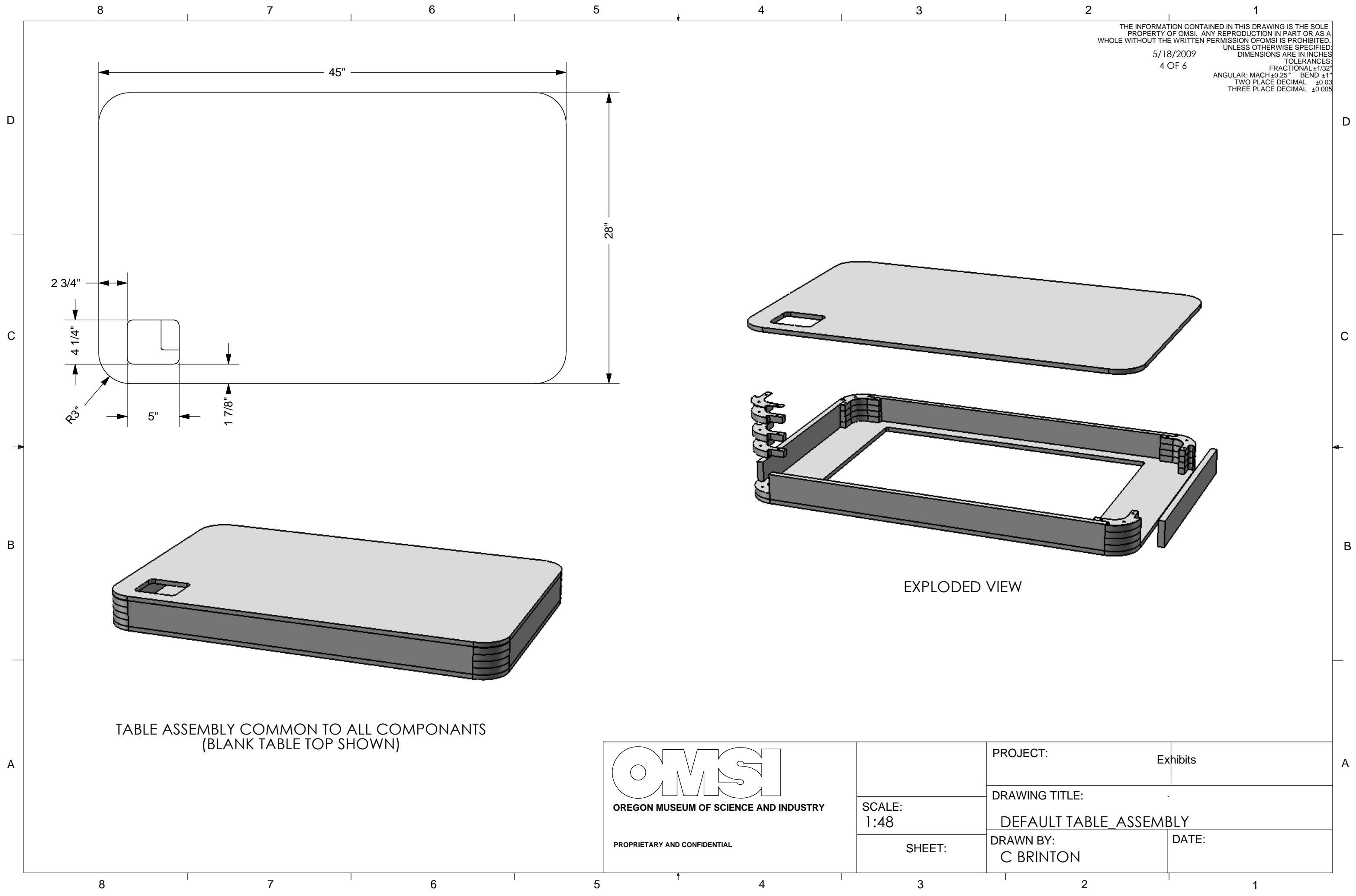



TABLE ASSEMBLY COMMON TO ALL COMPONENTS
(BLANK TABLE TOP SHOWN)

EXPLODED VIEW

 OREGON MUSEUM OF SCIENCE AND INDUSTRY PROPRIETARY AND CONFIDENTIAL	PROJECT: Exhibits
	DRAWING TITLE: DEFAULT TABLE ASSEMBLY
	DRAWN BY: C BRINTON DATE:
SCALE: 1:48	SHEET:

THE INFORMATION CONTAINED IN THIS DRAWING IS THE SOLE PROPERTY OF OMSI. ANY REPRODUCTION IN PART OR AS A WHOLE WITHOUT THE WRITTEN PERMISSION OF OMSI IS PROHIBITED. UNLESS OTHERWISE SPECIFIED: DIMENSIONS ARE IN INCHES TOLERANCES: FRACTIONAL $\pm 1/32"$ ANGULAR: MACH $\pm 0.25^\circ$ BEND $\pm 1^\circ$ TWO PLACE DECIMAL ± 0.03 THREE PLACE DECIMAL ± 0.005

5/18/2009
5 OF 6

REFER TO CAD DATA FOR COMPLETE DIMENSIONS

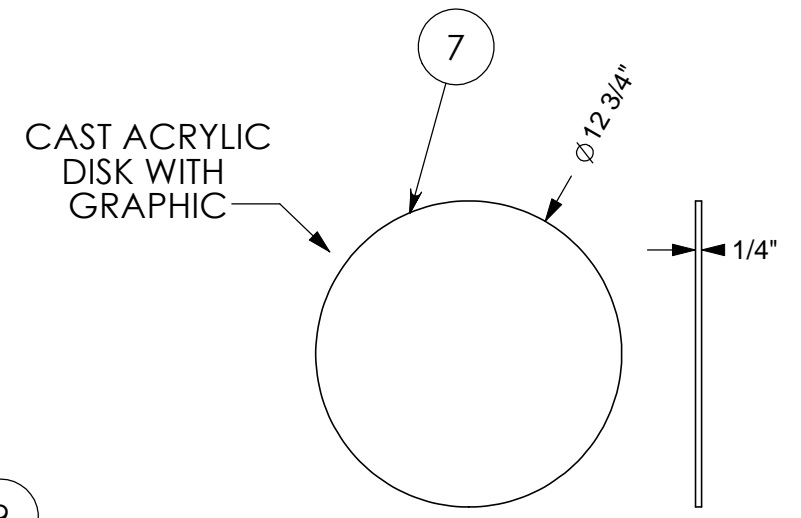
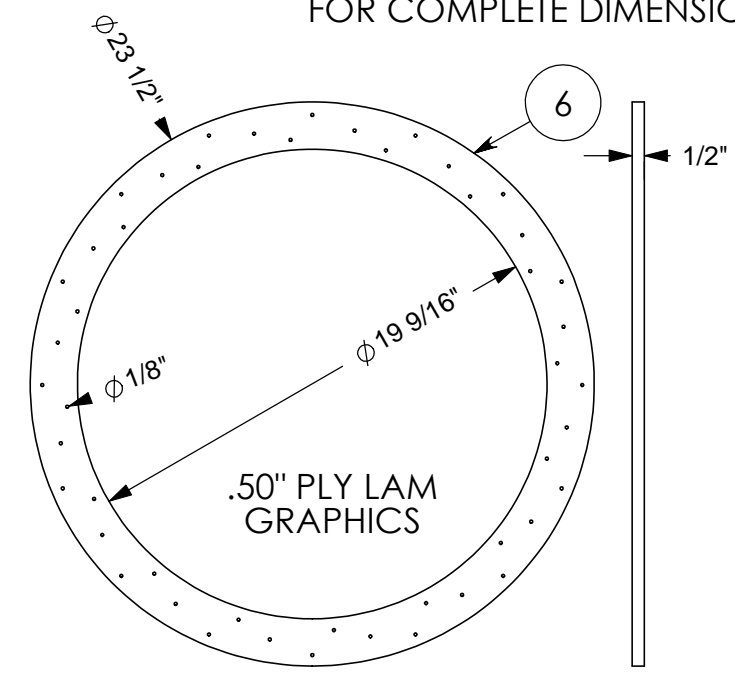
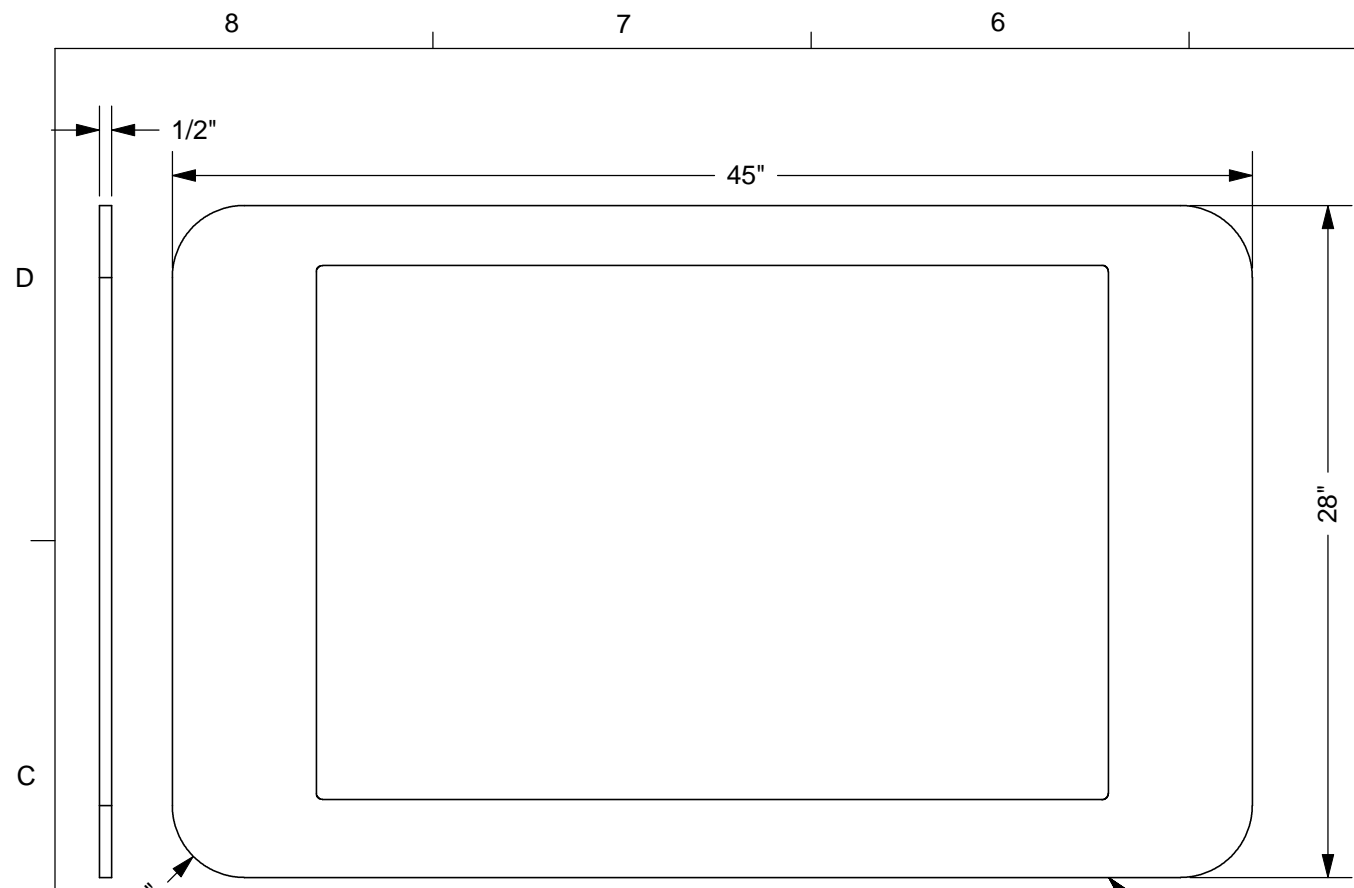

REFER TO CAD DATA FOR COMPLETE DIMENSIONS

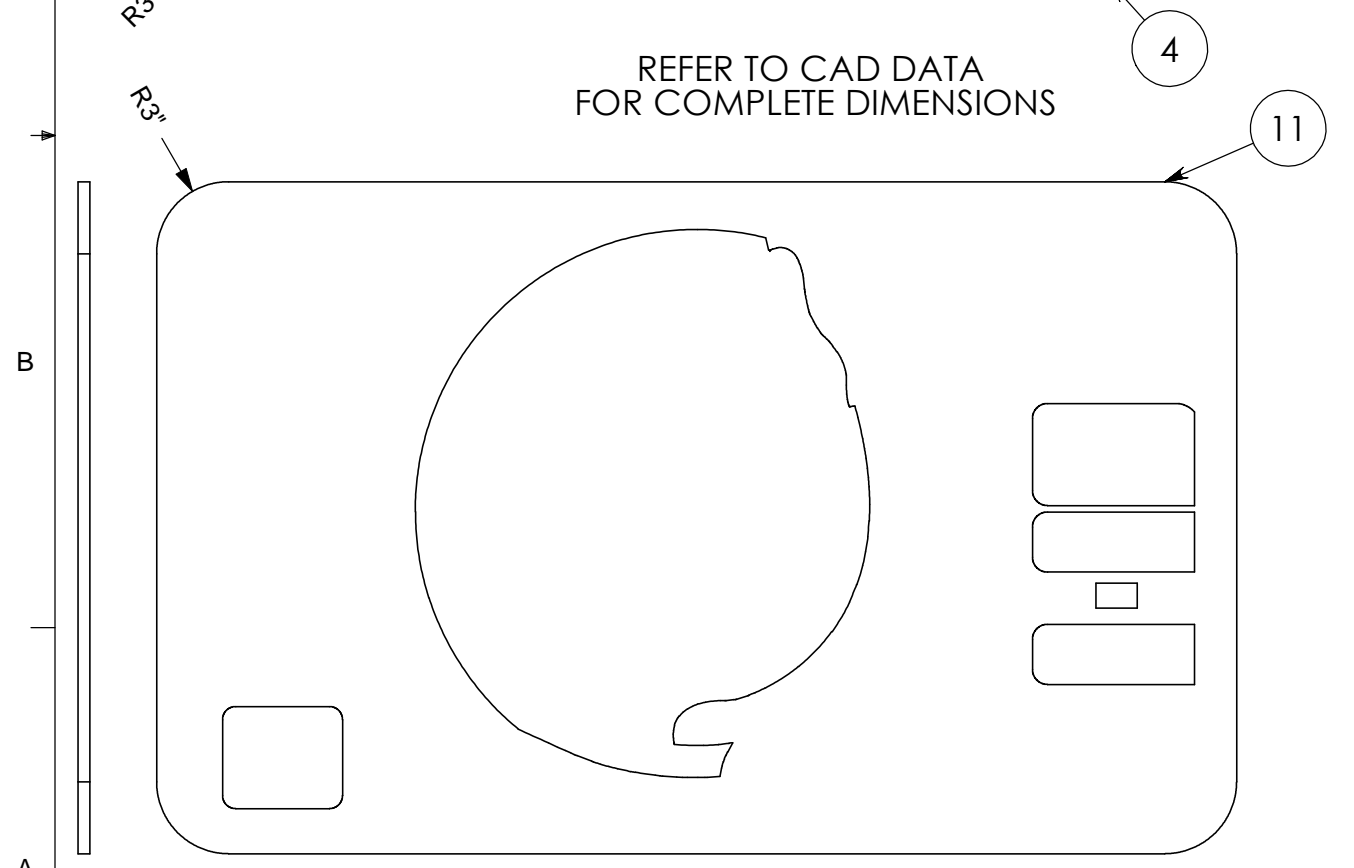

REFER TO CAD DATA FOR COMPLETE DIMENSIONS

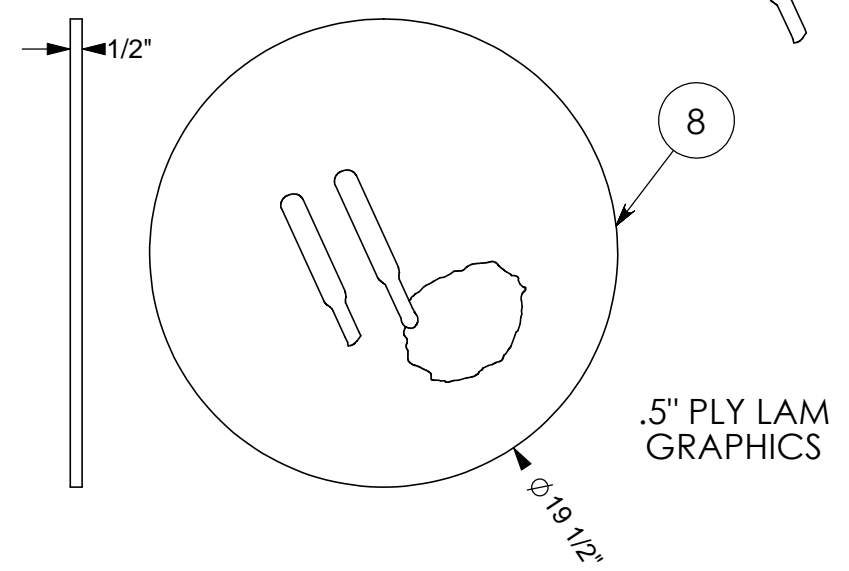

REFER TO CAD DATA FOR COMPLETE DIMENSIONS

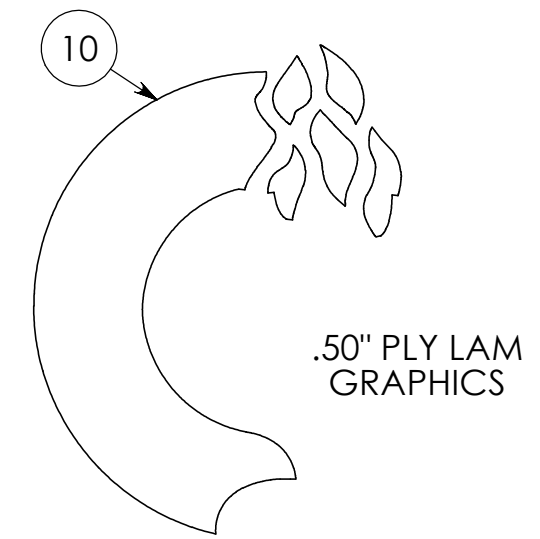

 OREGON MUSEUM OF SCIENCE AND INDUSTRY PROPRIETARY AND CONFIDENTIAL	PROJECT:	Exhibits
	SCALE:	1:48
	DRAWING TITLE:	GS_TOP TABLE CUT
SHEET:	DRAWN BY:	C BRINTON
	DATE:	

THE INFORMATION CONTAINED IN THIS DRAWING IS THE SOLE PROPERTY OF OMSI. ANY REPRODUCTION IN PART OR AS A WHOLE WITHOUT THE WRITTEN PERMISSION OF OMSI IS PROHIBITED. UNLESS OTHERWISE SPECIFIED: DIMENSIONS ARE IN INCHES TOLERANCES: FRACTIONAL ±1/32" ANGULAR: MACH ±0.25° BEND ±1° TWO PLACE DECIMAL ±0.03 THREE PLACE DECIMAL ±0.005

5/18/2009
6 OF 6

.25 INCH CLEAR ACRYLIC

.25 INCH CLEAR ACRYLIC

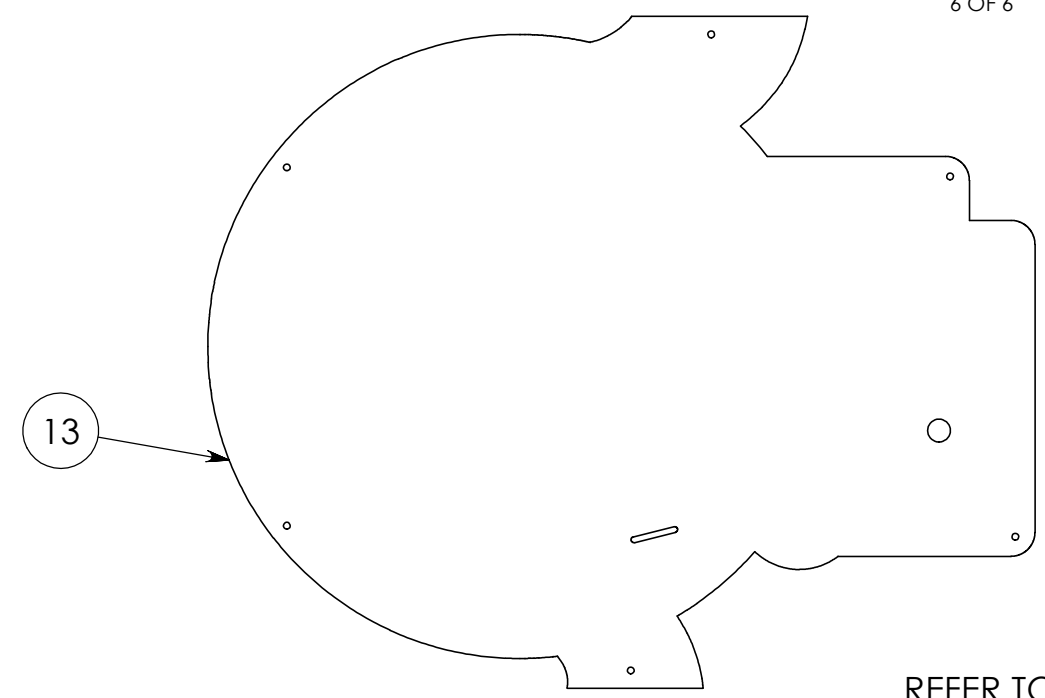
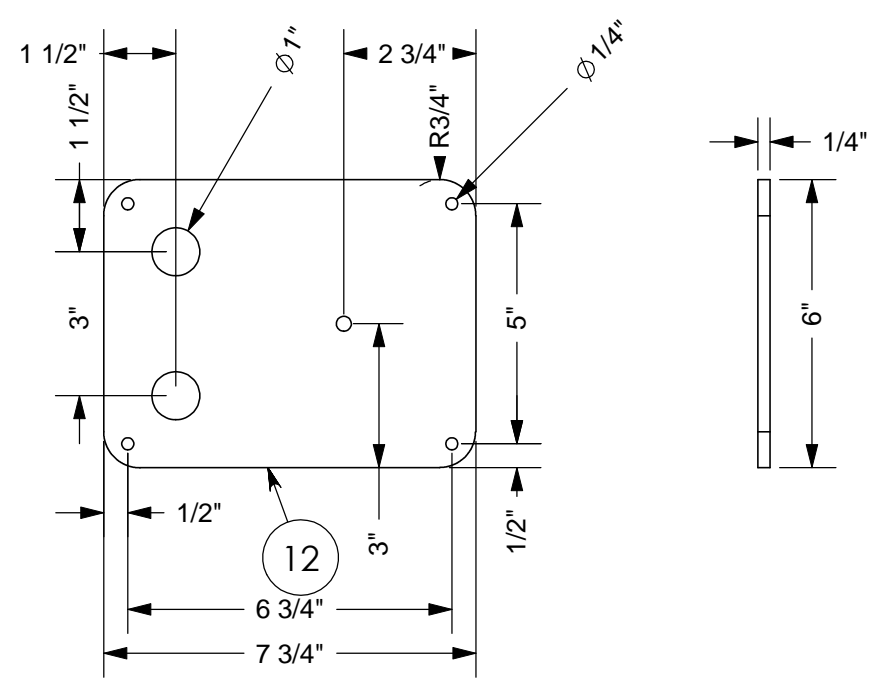

REFER TO CAD DATA FOR COMPLETE DIMENSIONS

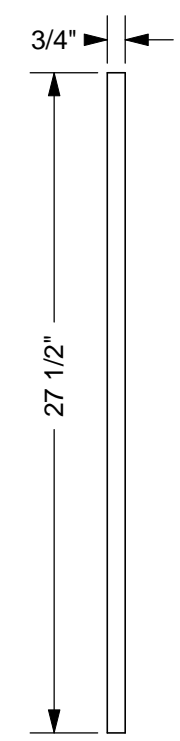
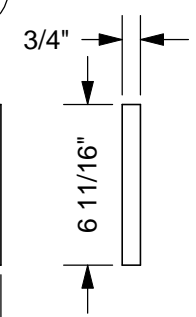
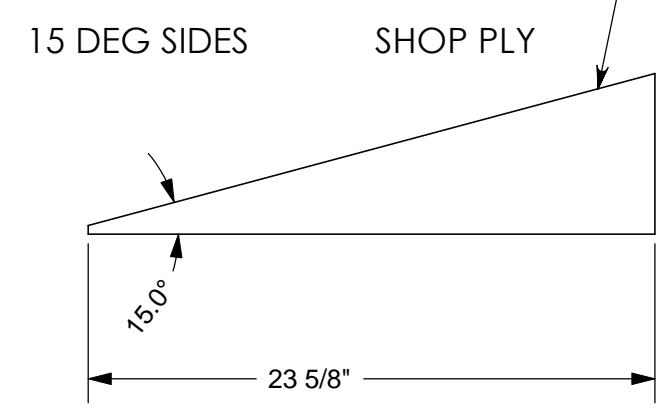

FRAME TABLE TOP

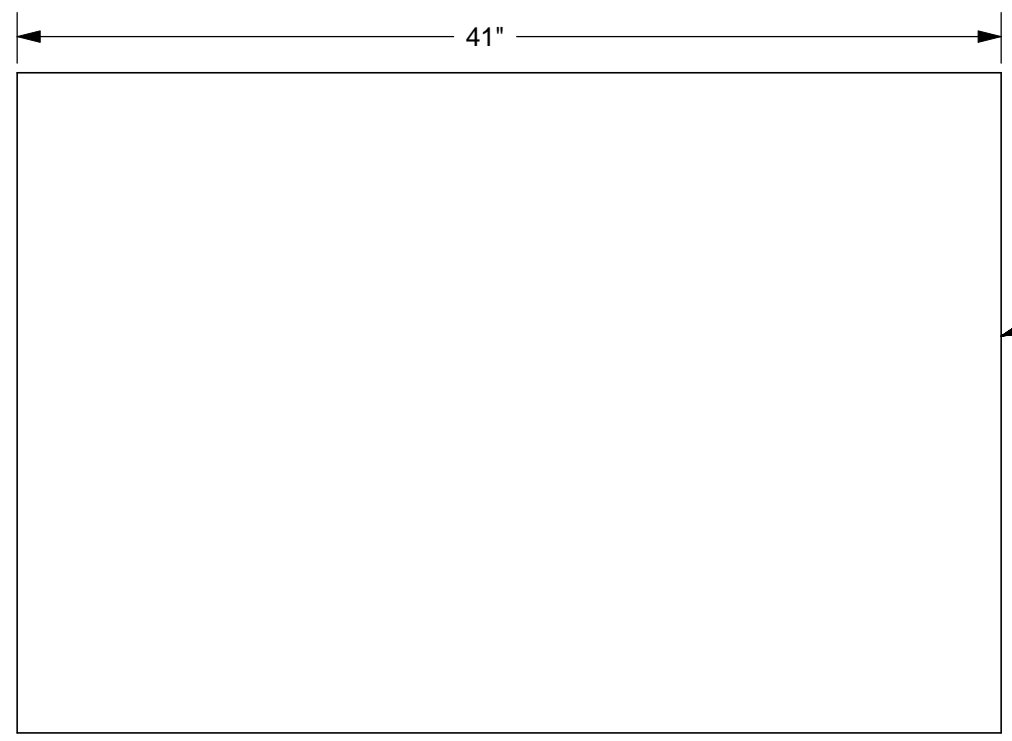

SHOP PLY

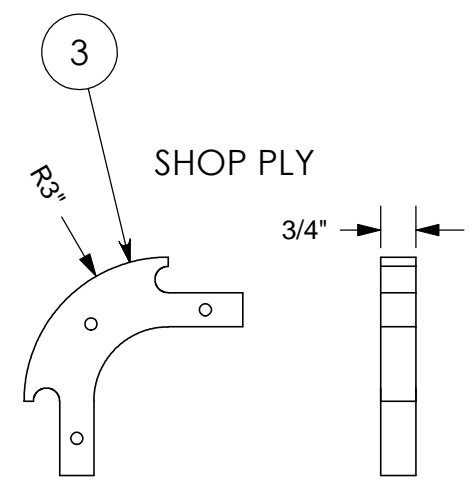

REFER TO CAD DATA FOR COMPLETE DIMENSIONS

 OREGON MUSEUM OF SCIENCE AND INDUSTRY PROPRIETARY AND CONFIDENTIAL	SCALE: 1:48	PROJECT: Exhibits
	SHEET:	DRAWING TITLE: Body183
		DRAWN BY: C BRINTON